

DESIGN MANUAL FOR EXCAVATION SUPPORT USING DEEP MIXING TECHNOLOGY

Cassandra RUTHERFORD, Giovanna BISCONTIN, and
Jean-Louis BRIAUD

TEXAS A&M UNIVERSITY



(pictures from Schnabel Foundation Company, www.schnabel.com)

MARCH 31, 2005

ACKNOWLEDGEMENTS

This manual is the result of a research project sponsored by the National Deep Mixing (NDM) pooled fund program and the Federal Highway Administration (FHWA). Mr. Ali Porbaha (CALTRANS) is the technical contact for NDM. Mr. Al DiMillio is the technical contact for FHWA. Mr. Victor Elias with SALUT is also thanked for his valuable advice. The authors thank their board of consultants namely Mr. George Tamaro of Mueser Rutledge Consulting Engineers, Mr. Demetrious Koutsoftas of Ove Arup and Partners, Dr. Tom O'Rourke of Cornell University and Mr. Dave Weatherby of Schnabel Foundations for their valuable contributions towards this project. The authors also wanted to thank the contributions of Dr. David Yang of Raito, Inc.

TABLE OF CONTENTS

CHAPTER 1 INTRODUCTION.....	14
1.1 PURPOSE AND SCOPE	14
1.2 APPLICATIONS AND LIMITATIONS	14
1.3 TYPES OF EXCAVATION SUPPORT	14
1.4 SELECTION OF DEEP MIXING METHOD.....	16
1.5 ORGANIZATION OF MANUAL.....	18
CHAPTER 2 DEEP MIXING METHOD	20
2.1 INTRODUCTION	20
2.2 DEFINITIONS.....	20
2.3 HISTORICAL BACKGROUND.....	20
2.4 DEEP MIXING METHOD FUNDAMENTALS.....	21
2.5 ADVANTAGES OF DEEP MIXING METHOD FOR EXCAVATION SUPPORT	24
2.6 LIMITATIONS OF DEEP MIXING METHOD FOR EXCAVATION SUPPORT.....	25
CHAPTER 3 GEOMATERIAL DESIGN.....	26
3.1 INTRODUCTION	26
3.2 FACTORS AFFECTING STRENGTH OF SOIL CEMENT	26
3.3 SELECTION OF MATERIAL PROPERTIES	27
3.4 MIX DESIGN	35
CHAPTER 4 CASE HISTORIES IN DEEP MIXING FOR EXCAVATION SUPPORT 37	
4.1 INTRODUCTION	37
4.2 CASE HISTORY 1 – EBMUD STORAGE BASIN, OAKLAND, CA	37
4.3 CASE HISTORY 2 – LAKE PARKWAY PROJECT, MILWAUKEE, WI	40
4.4 CASE HISTORY 3 – CENTRAL ARTERY/TUNNEL PROJECT: BIRD ISLAND FLATS, BOSTON, MA.....	43
4.5 CASE HISTORY 4 – HONOLULU EXCAVATION.....	45
4.6 CASE HISTORY 5 – OAKLAND AIRPORT ROADWAY PROJECT, OAKLAND, CA.....	48
4.7 CASE HISTORY 6 – VERT WALL, TEXAS A&M UNIVERSITY	51
CHAPTER 5 MODES OF FAILURE.....	54
5.1 INTRODUCTION	54
5.2 INSTABILITY DUE TO SEEPAGE	54
5.3 GLOBAL INSTABILITY.....	55
5.4 GEOTECHNCIAL FAILURE.....	57
5.5 STRUCTURAL FAILURE.....	58
CHAPTER 6 CANTILEVER AND SUPPORTED RETAINING WALL DESIGN.....	59
6.1 INTRODUCTION	59
6.2 SITE INVESTIGATION	59
6.3 GENERAL DESIGN PROCEDURES.....	60
6.4 SEEPAGE ANALYSIS.....	63
6.5 EXTERNAL STABILITY.....	65

6.6 CANTILEVER WALL DESIGN.....	66
6.7 SINGLE SUPPORT/TIEBACK WALL DESIGN.....	70
6.8 MULTIPLE SUPPORTS/TIEBACKS WALL DESIGN.....	76
6.9 COMPUTER AIDED ANALYSIS.....	78
6.10 VERTICAL CAPACITY OF WALL.....	83
6.11 STRUCTURAL RESISTANCE OF RETAINING ELEMENTS.....	84
6.12 MOVEMENTS.....	86
6.13 OTHER CONSIDERATIONS.....	90
CHAPTER 7 DESIGN EXAMPLES.....	91
7.1 INTRODUCTION.....	91
7.2 DESIGN EXAMPLE – CANTILEVER WALL.....	91
7.3 DESIGN EXAMPLE – SINGLE TIEBACK WALL AND MULTIPLE TIEBACK WALL	118
7.4 PROJECT DESIGN EXAMPLE 1 – BASED ON LAKE PARKWAY PROJECT, MILWAUKEE, WI.....	137
7.5 PROJECT DESIGN EXAMPLE 2 – BASED ON ISLAIS CREEK TRANSPORT/STORAGE SAN FRANCISCO, CA.....	143
CHAPTER 8 CONSTRUCTION.....	149
8.1 INTRODUCTION.....	149
8.2 CONSTRUCTION TECHNIQUES.....	149
8.3 SPOILS.....	153
8.4 PRE–CONSTRUCTION TESTING.....	153
8.5 PERFORMANCE DURING CONSTRUCTION.....	153
8.6 SPECIFICATIONS.....	153
CHAPTER 9 QUALITY ASSESSMENT AND PERFORMANCE MONITORING.....	154
9.1 INTRODUCTION.....	154
9.2 QUALITY ASSESSMENT METHODS.....	154
9.3 CORE SAMPLING AND TESTING.....	156
9.4 IN SITU TESTING.....	156
9.5 MONITORING TECHNIQUES.....	157
REFERENCES.....	158
APPENDIX A CHARTS FOR DESIGN.....	163
APPENDIX B SPECIFICATIONS.....	172
APPENDIX C DM CONTRACTOR INFORMATION.....	205

LIST OF FIGURES

Figure 1 – 1. Example of DM Excavation Support Construction Sequence	17
Figure 1 – 2. Marin Tower, Honolulu, HI Project Site	18
Figure 1 – 3. Marin Tower, Honolulu, HI Excavation Support System	18
Figure 2 – 1. Deep Mixing for Excavation Support Timeline	21
Figure 2 – 2. Strength Comparisons (Typical values)	22
Figure 2 – 3. Typical Arrangement of Soil Cement Columns	22
Figure 2 – 4. Soil Cement Excavation Support Wall.....	23
Figure 2 – 5. Hermann Hospital, Houston, TX Excavation.....	24
Figure 3 – 1. Histogram of Soil Cement Unconfined Compressive Strengths	29
Figure 3 – 2. Effect of Soil Type on Strength.....	30
Figure 3 – 3. Effect of Grain Size Distribution on Strength	31
Figure 3 – 4. Permeability of Soil Cement	32
Figure 3 – 5. Correlation between Permeability and Pore Size Distribution.....	32
Figure 3 – 6. Correlation of Young’s Modulus and Strength	34
Figure 3 – 7. Shear Modulus as a Function of Radial and Engineering Strain for FPC Soil Mix ..	35
Figure 4 – 1. Lateral Deformation Profiles	39
Figure 4 – 2. Lake Parkway Project.....	40
Figure 4 – 3. Typical Wall Plan.....	41
Figure 4 – 4. CA/T Project, Boston, MA.....	43
Figure 4 – 5. Marin Tower, Honolulu, HI Project Site	45
Figure 4 – 6. Marin Tower, Honolulu, HI Excavation Support System	47
Figure 4 – 7. Design of Gravity Wall	49
Figure 4 – 8. Completed VERT Wall	51
Figure 4 – 9. VERT Wall Displacements	53
Figure 5 – 1. Boiling/Piping.....	54
Figure 5 – 2. Plug Heave.....	55
Figure 5 – 3. Global Instability wall	56
Figure 5 – 4. Inverted Bearing Capacity	56
Figure 5 – 5. Geotechnical Failures	57
Figure 5 – 6. Structural Failure	58
Figure 6 – 1. Cantilever, Single Support and Multiple Support Walls	61
Figure 6 – 2. Repeatable Section	61
Figure 6 – 3. Deep Mixing Excavation Support Wall Design Flowchart.....	62
Figure 6 – 4. Typical Flownet for a Retaining Wall.....	63
Figure 6 – 5. Plug Heave When the Site Consists of Clay over Sand	64
Figure 6 – 6. Circular Slip Failure	65
Figure 6 – 7. Inverted Bearing Capacity	65
Figure 6 – 8. Cantilever Wall.....	66
Figure 6 – 9. Earth Pressures for Effective Stress Analysis	68

Figure 6 – 10. Earth Pressures for Undrained Total Stress Analysis.....	69
Figure 6 – 11. Earth Pressures for Excavation Support Systems.....	70
Figure 6 – 12. Single Tieback Wall.....	71
Figure 6 – 13. Earth Pressure Coefficient Versus Top Deflection.....	73
Figure 6 – 14. Earth Pressure Coefficient Versus Mean Wall Deflection.....	74
Figure 6 – 15. Apparent Earth Pressure.....	75
Figure 6 – 16. Multiple Tieback Wall.....	76
Figure 6 – 17. Apparent Earth Pressure Multiple Tieback.....	77
Figure 6 – 18. Boundary Element Model of Repeatable Section of Wall.....	78
Figure 6 – 19. Finite Element Method Parameters (After Briaud and Lim, 1999).....	81
Figure 6 – 20. Comparison of Quality of Bending Moment and Deflection Results.....	83
Figure 6 – 21. Vertical Capacity of Soil Cement Column.....	84
Figure 6 – 22. Stress Distribution in Soil Cement Wall.....	85
Figure 6 – 23. Soil Cement Arching and Shearing.....	86
Figure 6 – 24. Design Curves to Obtain Maximum Lateral Wall Movement (or Soil Settlement) for Soft to Medium Clays.....	87
Figure 6 – 25. Dimensionless Settlement Profiles Recommended for Estimating the Distribution of Settlement Adjacent to Excavations in Different Soil Types.....	88
Figure 6 – 26. Observed Maximum Lateral Movements for In situ Walls in Stiff Clays Residual Soils and Sands.....	89
Figure 6 – 27. Predicted Maximum Lateral Wall Movements by Finite Element Analysis Modeling Stiff Soil Conditions.....	90
Figure 7 – 1. Cross Section of Cantilever with Soil Properties (Case 1a).....	92
Figure 7 – 2. Base Stability for Cantilever Wall (Case 1a).....	93
Figure 7 – 3. Active and Passive Earth Pressure Diagrams (Case 1a).....	94
Figure 7 – 4. Final Dimensions of Wall (Case 1a).....	95
Figure 7 – 5. Bending Failure Check.....	96
Figure 7 – 6. Shear Failure Check.....	97
Figure 7 – 7. Cross Section of Cantilever with Soil Properties (Case 1b).....	98
Figure 7 – 8. Base Stability for Cantilever Wall (Case 1b).....	100
Figure 7 – 9. Active and Passive Pressure Diagrams (Case 1b).....	101
Figure 7 – 10. Cross Section of Cantilever with Soil Properties (Case 2a).....	102
Figure 7 – 11. Base Stability Cantilever Wall (Case 2a).....	103
Figure 7 – 12. Active and Passive Earth Pressure Diagrams (Case 2a).....	104
Figure 7 – 13. Final Dimensions of Wall Using Effective Stress Analysis (Case 2a).....	105
Figure 7 – 14. Cross Section of Cantilever with Soil Properties (Case 2b).....	106
Figure 7 – 15. Base Stability for Cantilever Wall (Case 2b).....	107
Figure 7 – 16. Active and Passive Diagrams Using Effective Stress Analysis for Cantilever Wall (Case 2b).....	108
Figure 7 – 17. Active and Passive Diagrams Using Undrained Total Stress Analysis for Cantilever Wall (Case 2b).....	110
Figure 7 – 18. Cross Section of Cantilever with Soil Properties (Case 3a).....	112
Figure 7 – 19. Base Stability for Cantilever Wall (Case 3a).....	113
Figure 7 – 20. Active and Passive Earth Pressure Diagrams (Case 3a).....	114
Figure 7 – 21. Final Dimension of Cantilever Wall (Case 3a).....	115

Figure 7 – 22. Cross Section of Cantilever with Soil Properties (Case 3b).....	116
Figure 7 – 23. Plug Heave (Case 3b).....	117
Figure 7 – 24. Cross Section of Single Anchor Wall with Soil Properties (Case 1a).....	118
Figure 7 – 25. Base Stability for Single Anchor Wall (Case 1a).....	119
Figure 7 – 26. Earth Pressure Diagrams for Single Anchor Wall (Case 1a).....	120
Figure 7 – 27. Tributary Area Method.....	121
Figure 7 – 28. Cross Section of Single Anchor Wall with Soil Properties (Case 1b).....	123
Figure 7 – 29. Base Stability for Single Anchor Wall (Case 1b).....	124
Figure 7 – 30. Earth Pressure Diagrams for Single Anchor Wall (Case 1b).....	126
Figure 7 – 31. Cross Section of Single Anchor Wall with Soil Properties (Case 2a).....	128
Figure 7 – 32. Base Stability for Single Anchor Wall (Case 2a).....	128
Figure 7 – 33. Earth Pressure Diagrams Single Anchor Wall (Case 2a).....	130
Figure 7 – 34. Cross Section of Single Anchor Wall with Soil Properties (Case 1b).....	132
Figure 7 – 35. Base Stability for Single Anchor Wall (Case 2b).....	133
Figure 7 – 36. Earth Pressure Diagrams on Single Anchor Wall (Case 2b).....	135
Figure 7 – 37. Cross Section of Lake Parkway Two Tier Anchor Wall (Design Example 1)...	137
Figure 7 – 38. Cross Section of Two Tier Wall (Design Example 1).....	138
Figure 7 – 39. Earth Pressure Diagrams for Two Tier Wall (Design Example 1).....	140
Figure 7 – 40. Bending Failure Check for Two Tier Wall (Design Example 1).....	141
Figure 7 – 41. Shear Failure Check for Two Tier Wall (Design Example 1).....	142
Figure 7 – 42. Cross Section of Army (Cesar Chavez) Street Shoring System (Design Example 2).....	143
Figure 7 – 43. Earth Pressure Diagrams for Army (Cesar Chavez) Street Shoring System (Design Example 2).....	145
Figure 7 – 44. Bending Failure Check for Army (Cesar Chavez) Street Shoring System (Design Example 2).....	147
Figure 7 – 45. Shear Failure Check for Army (Cesar Chavez) Street Shoring System (Design Example 2).....	148
Figure 8 – 1. Construction Operation Flowchart.....	149
Figure 8 – 2. Three Auger DM Equipment.....	150
Figure 8 – 3. DM Equipment at CA/T Project, Boston, MA.....	151
Figure 8 – 4. Batch Mixing Plant.....	152
Figure 8 – 5. DM Wall Installation Process.....	153
Figure 9 – 1. Flowchart for Quality Control and Quality Assurance.....	154
Figure 9 – 2. Sampling Tool.....	156
Figure A – 1. Penetration of Cutoff Wall to Prevent Piping in Isotropic Sand.....	164
Figure A – 2. Penetration of Cutoff Wall to Prevent Piping in Stratified Sand.....	165
Figure A – 3. Bottom Heave.....	166
Figure A – 4. Base Stability.....	167
Figure A – 5. Earth Pressures for Sand.....	168
Figure A – 6. Adjusted Earth Pressures.....	170

LIST OF TABLES

Table 1 – 1. Comparison of Types of Excavation Support.....	15
Table 1 – 2. Comparison of Methods Used for Excavation Support.....	15
Table 1 – 3. Comparison of Excavation Support using Ground Improvement Techniques.....	16
Table 2 – 1. Deep Mixing Acronyms and Terminology.....	20
Table 3 – 1. Factors Affecting Soil Cement Strength.....	26
Table 3 – 2. Summary of Unconfined and UU Compressive Strength.....	28
Table 3 – 3. Young’s Moduli.....	33
Table 6 – 1. Comparison of Design Methods.....	59
Table 7 – 1. Cantilever Design Example Cases.....	91
Table 7 – 2. Earth Pressure and Kickback Force Calculations (Case 1a).....	94
Table 7 – 3. Factor of Safety Calculations for Various Embedment Depths (Case 1a).....	95
Table 7 – 4. Earth Pressure and Force Calculations (Case 1b).....	100
Table 7 – 5. Factor of Safety Calculations (Case 1b).....	101
Table 7 – 6. Earth Pressure and Force Calculations (Case 2a).....	103
Table 7 – 7. Factor of Safety Calculations for Various Embedment Depths (Case 2a).....	104
Table 7 – 8. Earth Pressure and Force Using Effective Stress Analysis (Case 2b).....	108
Table 7 – 9. Earth Pressure and Force Calculations Using Total Stress Analysis (Case 2b)....	109
Table 7 – 10. Factor of Safety Calculations Using Effective Stress Analysis (Case 2b).....	110
Table 7 – 11. Factor of Safety Calculations Using Total Stress Analysis (Case 2b).....	110
Table 7 – 12. Earth Pressure and Force Calculations (Case 3a).....	113
Table 7 – 13. Factor of Safety Calculations (Case 3a).....	114
Table 7 – 14. Single Support/Tieback Wall Design Example Cases.....	118
Table 7 – 15. Apparent Earth Pressure for Single Support/Tieback Wall (Case 1a).....	119
Table 7 – 16. Earth Pressure Calculations for Single Support/Tieback Wall (Case 1a).....	120
Table 7 – 17. Factor of Safety and Force Calculations for Single/Tieback Wall (Case 1a).....	121
Table 7 – 18. Horizontal Earth Pressure for Single Anchor Wall (Case 1b).....	125
Table 7 – 19. Earth Pressure Calculations for Single Anchor Wall (Case 1b).....	125
Table 7 – 20. Factor of Safety and Kickback Force Calculations for Single Support/Tieback.	126
Table 7 – 21. Apparent Earth Pressure Calculations for Single Support/Tieback Wall (Case 2a)	129
Table 7 – 22. Earth Pressure Calculations for Single Support/Tieback Wall (Case 2a).....	129
Table 7 – 23. Factor of Safety and Kickback Force Calculations for Single Support/Tieback Wall (Case 2a).....	130
Table 7 – 24. Horizontal Earth Pressure for Single Anchor Wall (Case 2b).....	134
Table 7 – 25. Earth Pressure Calculations for Single Anchor Wall (Case 2b).....	134
Table 7 – 26. Factor of Safety and Kickback Force Calculations for Single Support/Tieback Wall (Case 2b).....	135
Table 7 – 27. Apparent Earth Pressure for Two Tier Wall (Design Example 1).....	138
Table 7 – 28. Earth Pressure Calculations for Two Tier Wall (Design Example 1).....	139
Table 7 – 29. Factor of Safety and Kickback Force Calculations for Two Tier.....	140

Table 7 – 30. Wide Flange Properties (Design Example 1)	141
Table 7 – 31. Apparent Earth Pressure for Army (Cesar Chavez) Street Shoring System (Design Example 2)	144
Table 7 – 32. Earth Pressure Calculations for Army (Cesar Chavez) Street Shoring System (Design Example 2)	145
Table 7 – 33. Factor of Safety and Kickback Force Calculations for Army (Cesar Chavez) Street Shoring System (Design Example 2)	146
Table 7 – 34. Wide Flange Properties (Design Example 2)	146
Table 9 – 1. Types of Instruments Used	157
Table A – 1. Wall Friction	169

LIST OF ABBREVIATIONS AND SYMBOLS

A = area of plug

aw = cement content, dry weight of cement to dry weight of original soil

BEM = boundary element method

BMCOL = beam column method

c = effective stress cohesion intercept of the soil

CA/T = Central Artery/Tunnel

CCP = chemical churning pile

CDM = cement deep mixing

CF = cement factor

CPT = standard cone penetrometer test

D = embedment depth

D' = distance from bottom of excavation to impervious layer

DCCM = deep cement continuous method

DCM = deep chemical mixing

DeMIC = deep mixing improvement by cement stabilization

DJM = dry jet mixing

DLM = deep lime mixing

DM = deep mixing

DMM = deep mixing method

DSM = deep soil mixing

E = modulus of deformation of soil

EBMUD = East Bay Municipal Utility District

EI = wall stiffness

$E_{\text{Soil/Grout}}$ = Young's modulus of soil grout

F = factor of safety

f'_e = unconfined compressive strength

FEM = finite element method

FPC = Fort Point Channel

F_u = uplift force

G_{max} = maximum secant modulus

G_{sec} = secant modulus

GWT = ground water table

h = average spacing between supports

H = height of wall

H_c = height of clay layer

$H_{c(\text{design})}$ = height of clay layer for design

$H_{c(\text{failure})}$ = height of clay layer at failure

H_w = height of water from bottom of excavation

H_1 = height from top of wall to first anchor

H_2 = height from first anchor to second anchor

H_3 = height from second anchor to third anchor

I = moment of inertia for a unit length of wall

JACSMAN = jet and churning system management

k = coefficient of apparent earth pressure

k = permeability

K_a = active earth pressure coefficient

k_{anchor} = stiffness of anchor

K_p = passive earth pressure coefficient

P_a = resultant of active earth pressure

P_p = resultant of passive earth pressure

q = surcharge

q_u = unconfined compressive strength

q_n = downdrag force from friction between the soil and the repeatable section of the wall

R = kickback force

r_b = resistance of the bottom of the repeatable section of the wall

RM = rectangular mixing method

r_w = resistance of the repeatable section of the wall

S = system stiffness

SLC = Swedish lime column

SWING = spreadable WING method

SWM = soil mix wall

S_u = undrained shear strength for fine grained soils

T = anchor load

u = water stress (pore water pressure if saturated soil)

UCS = unconfined compressive strength

V = vertical component of each anchor force

w = half the weight of the excavation

W = weight of plug

W = weight of the repeatable section of the wall

w/c = water to cement ratio

α = ratio of water over total pore area (use 0 for unsaturated soils or soils in the capillary zone and 1 for saturated soils under the GWT)

β = varies between 0.2 to 0.4 for clay

$\Delta \sigma_v$ = change in vertical total stress at depth z (due to load at the surface of the retained side)

$\Delta \sigma'_v$ = change in vertical effective stress at depth z (due to load at the surface of the retained side)

ϕ = effective stress internal friction angle

γ = unit weight of soil

γ_t = total unit weight of soil

γ_w = unit weight of water

σ_{ah} = total active earth pressure

σ_{apparent} = apparent total earth pressure

σ_h = constant total horizontal pressure above excavation

σ_{ph} = total passive earth pressure

σ_{ov} = initial vertical total stress

σ'_{ov} = initial vertical effective stress

CHAPTER 1

INTRODUCTION

1.1 PURPOSE AND SCOPE

The main goal of this manual is to develop state-of-the-practice guidelines for the design of excavation support systems using deep mixing technology in alternative or in conjunction with traditional techniques. The purpose of this manual is to facilitate the implementation of deep mixing (DM) technology into American excavation support design and construction practices, and answer deep mixing technology design questions.

1.2 APPLICATIONS AND LIMITATIONS

This design manual is intended to emphasize the principles for design of excavation support using deep mixing technology. Current state-of-the-practice case histories are also presented. This manual is not intended to be an all inclusive, prescriptive set of rules for deep mixing design. Its aim is to provide the engineer with background information and recommendations to confidently design DM excavation support walls.

1.3 TYPES OF EXCAVATION SUPPORT

A variety of excavation support methods are currently used in practice. The prevalence of one shoring system over the others in a certain region depends on several factors including: local experience, site conditions, availability and cost of materials and the amount of shoring required for the project. The advantages and limitations of common types of excavation support were compiled based on general knowledge and consultant input (Table 1 – 1).

Table 1 – 1. Comparison of Types of Excavation Support

Excavation Support System	Advantages	Limitations
Structural Diaphragm (Slurry) Wall	Constructed before excavation and below ground water, good water seal, can be used for permanent wall and can be used in most soils. Relatively high stiffness. Can become part of the permanent wall.	Large volume of spoils generated and disposal of slurry required. Costly compared to other methods. Must be used with caution or special techniques must be used when adjacent to shallow spread footing.
Sheetpile Wall	Constructed before excavation and below ground water. Can be used only in soft to medium stiff soils. Quickly constructed and easily removed. Low initial cost.	Cannot be driven through complex fills, boulders or other obstructions. Vibration and noise with installation. Possible problems with joints. Limited depth and stiffness. Can undergo relatively large lateral movements.
Soldier Pile and Lagging Wall	Low initial cost. Easy to handle and construct.	Lagging cannot be practically installed below groundwater. Cannot be used in soils that do not have arching or that exhibit base instability. Lagging only to bottom of excavation and pervious.
Secant Wall/Tangent Pile Wall (similar to DM walls)	Constructed before excavation and below ground water. Low vibration and noise. Can use wide flange beams for reinforcement.	Equipment cannot penetrate boulders, requires pre-drilling. Continuity can be a problem if piles drilled one at a time.
Micro-pile Wall	Constructed before excavation and below ground water. Useful when limited right of way.	Large number required. Continuity a problem, low bending resistance.

Information regarding the advantages and limitations of various support methods used for excavations was compiled based on general knowledge and expert consultation (Table 1 – 2). Site conditions often control the use of tieback/anchors compared to internal struts.

Table 1 – 2. Comparison of Methods Used for Excavation Support

Excavation Support Method	Advantages	Limitations
Tieback Supporting Wall	Reduces depth of structure below trench, keeps overhead clear during excavation. Can be permanent under limited conditions.	Cannot install tiebacks below groundwater, Easements required if outside property limits.
Internal Struts Supporting Wall	Does not extend beyond excavation walls, reduces depth of wall.	Overhead and lateral obstruction for excavation of trench. Subjected to temperature changes, requires internal vertical support for wide excavations.

Ground improvement techniques have evolved of the last decades and are commonly used for stabilizing excavations. Table 1 – 3 compares ground improvement techniques used for excavation support. Comparisons are based on consultant observations and compiled general knowledge.

Table 1 – 3. Comparison of Excavation Support using Ground Improvement Techniques

Excavation Support using Ground Improvement	Advantages	Limitations
Deep Mixing Method	Constructed before excavation and below ground water. Low vibration and noise levels. Fast construction. Reduced excavated spoils compared to slurry (diaphragm) walls. Improved continuity with multi-drill tool.	Difficult with boulders and utilities, spoils generated.
Permeation Grouting	Constructed before excavation and below ground water.	Pre-grouting to control flow of grout through cobbles, do not penetrate soil with more than 15% fines.
Soil Nailing	Rapid construction, boulders could be drilled through. Can be used in stiff soils.	Cannot install below groundwater, easements required, cannot be used in soft soils or soils that exhibit base instability. Excavation must have a stable face prior to installation.
Jet Grouting	Constructed before excavation and below ground water.	Difficult with boulders, large volume of spoils generated. Obstructions can obstruct lateral spread of mixing
Soil Freezing	Constructed before excavation and below ground water.	Difficult to install with flowing groundwater and around boulders very costly for large area and/or prolonged time. Temporary. Ground heave during freezing and settlement during thaw.

1.4 SELECTION OF DEEP MIXING METHOD

The initial feasibility of the application of DM to excavations is dependent on site conditions and economics. Sites with ground settlement sensitivity, vibration sensitivity, high groundwater table, and/or soft soils are often good candidates for the use of DM. Since the placement of DM columns causes little disturbance to surroundings when rotation/extraction is controlled, the method can be used in soils close to a building's foundation. Economic considerations for

determining the advantage of deep mixing versus traditional techniques differ 1) regionally, due to many factors such as availability of equipment, materials, labor; and 2) based on the details of the project. Appendix C compiles information regarding deep mixing technology from various contactors. As with all other excavation support techniques, the presence of utilities, subways, or other underground structures may determine whether or not deep mixing is viable at a site. The presence of underground facilities affects other excavation support systems as well. DM is likely to produce the least amount of disruption and adverse impacts compared to other methods. Stiff layers of soil may require pre-drilling to ensure homogenous soil cement columns. Figure 1 – 1, created based on procedures described by Yang and Takeshima (1994) and industry experts, illustrates the construction sequence for DM excavation support. Specialized equipment is used to install the soil cement columns. Typically, a 3 or 5-axis auger is used to create the initial columns (Step 1). Using a template, the second set of columns are installed spaced one column diameter from the initial set (Step 2). A continuous panel of soil cement columns is created by re-mixing the first and last column of each set (Step 3). Skipping one column space between steps 2 and 3 allows for column 3 and 5 to be re-mixed and ensure an impermeable continuous panel is created. To aid in lateral reinforcement, H-beams are installed into every other column before the soil cement is allowed to cure (Step 4).

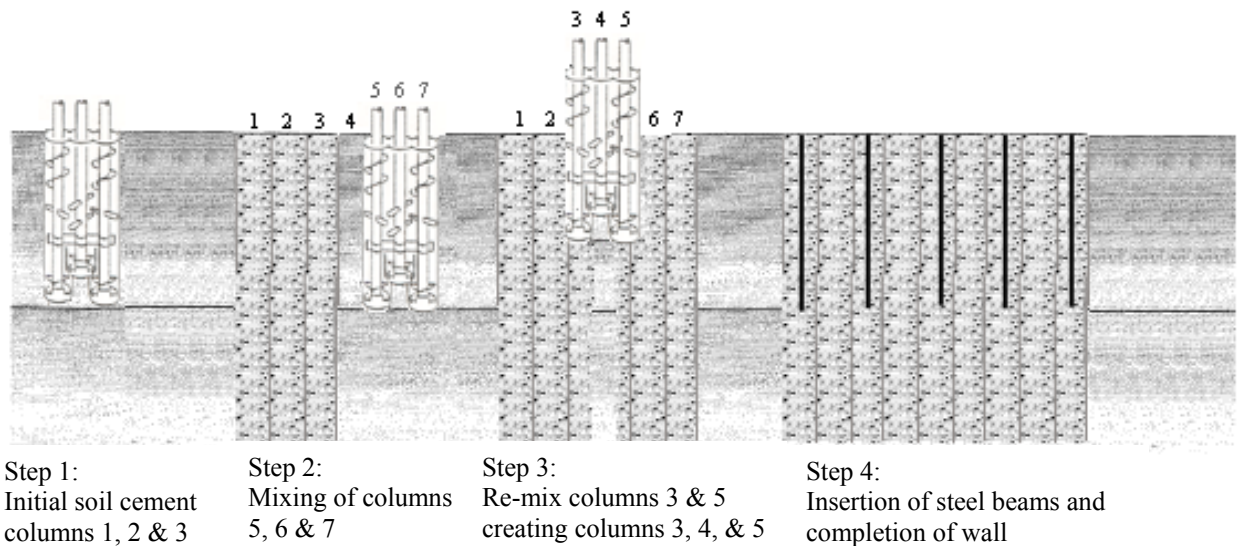

Figure 1 – 1. Example of DM Excavation Support Construction Sequence

Figure 1 – 2 and Figure 1 – 3 depict the soil cement excavation wall at Marin Tower, Honolulu, HI. The Marin Tower project was the first use of deep mixing incorporated into a tiebacked earth retention design in the United States (Yang and Takeshima, 1994). Due to the high water levels and permeable coral ridge and coralline deposits, sheet piling was not a feasible option for the excavation support. Deep mixing was successfully used as temporary excavation support and cutoff walls. The project is discussed in more detail in section 4.5.



Figure 1 – 2. Marin Tower, Honolulu, HI Project Site
(Picture from Schnabel Foundation Company, www.schnabel.com)



Figure 1 – 3. Marin Tower, Honolulu, HI Excavation Support System
(Picture from Schnabel Foundation Company, www.schnabel.com)

1.5 ORGANIZATION OF MANUAL

Chapter 1 (Introduction) provides application and limitations of deep mixing for excavation support. The advantages and disadvantages of the current types of excavation support are compared. The feasibility of using the deep mixing method for excavation support is also

presented. Chapter 2 (Deep Mixing Method) defines various acronyms associated with deep mixing, presents a brief historical background, outlines deep mixing fundamentals and discusses the advantages and limitations of deep mixing. Chapter 3 (Geomaterial Design) discusses the factors related to geomaterial design and material properties. Chapter 4 (Case Histories in Deep Mixing for Excavation Support) presents six case histories of current practice projects. Chapter 5 (Mode of Failures) illustrates the modes of failure considered for design and Chapter 6 (Cantilever and Supported Wall Design) details the design methodologies and considerations for excavation support. Chapter 7 (Design Examples) provides step-by-step design examples. Chapters 8 (Construction) and 9 (Quality Assessment and Performance Monitoring) review construction, quality assessment and performance monitoring aspects, respectively, followed by the references. Appendix A presents charts for the hand calculation approach in the design chapter. Appendix B provides examples specifications. Appendix C compiles information from various deep mixing contractors.

CHAPTER 2

DEEP MIXING METHOD

2.1 INTRODUCTION

Deep mixing (DM) is the modification of in situ soil to increase strength, control deformation, and reduce permeability. Multi-axis augers and mixing paddles are used to construct overlapping columns strengthened by mixing cement with in situ soils. This method has been used for excavation support to increase bearing capacity, reduce movements, prevent sliding failure, control seepage by acting as a cut-off barrier, and as a measure against base heave.

2.2 DEFINITIONS

Deep mixing technology has a variety of associated acronyms and terminology. Table 2 – 1 defines current terms used in deep mixing industry and research. Other phrases include mixed-in-place piles, in situ soil mixing, lime-cement columns and soil cement columns. This guideline will refer to deep mixing (DM) and the resulting product as soil cement columns.

Table 2 – 1. Deep Mixing Acronyms and Terminology (After Porbaha, 1998)

Acronym	Terminology
SMW	soil mix wall
DSM	deep soil mixing
DCM	deep chemical mixing
CDM	cement deep mixing
DMM	deep mixing method
CCP	chemical churning pile
DCCM	deep cement continuous method
DJM	dry jet mixing
DLM	deep lime mixing
SWING	spreadable WING method
RM	rectangular mixing method
JACSMAN	jet and churning system management
DeMIC	deep mixing improvement by cement stabilization

2.3 HISTORICAL BACKGROUND

Excavation support using DM has evolved since the early 1970's from Japanese practice in which single soil cement columns were created to support excavations and act as cutoff walls (Bruce et al., 1998). Steel reinforcement, usually wide flange H-beams or sheet piles, was placed in the columns to resist lateral forces. This technique developed into a method commonly referred to as the Soil Mixed Wall (SMW) method. Deep mixing was researched in Sweden in

the late 1970's with the development of the Swedish Lime Column (SLC). The first major application of deep soil mixing for excavation support in the United States was the Wet Weather Storage Basin for the East Bay Municipal Utility District (EBMUD) project in Oakland, California, constructed in 1990 (Taki and Yang, 1991). Numerous projects have incorporated deep mixing for temporary excavation support and base stability since that time (Pearlman and Himick, 1993; Yang and Takeshima, 1994; O'Rourke and O'Donnell, 1997; Bahner and Naguib, 1998; Bruce, 2000; McMahon et al. 2001; Yang 2003). A timeline of deep mixing for excavation support created by summarizing a variety of publications and industry expert experience is shown in Figure 2 – 1.

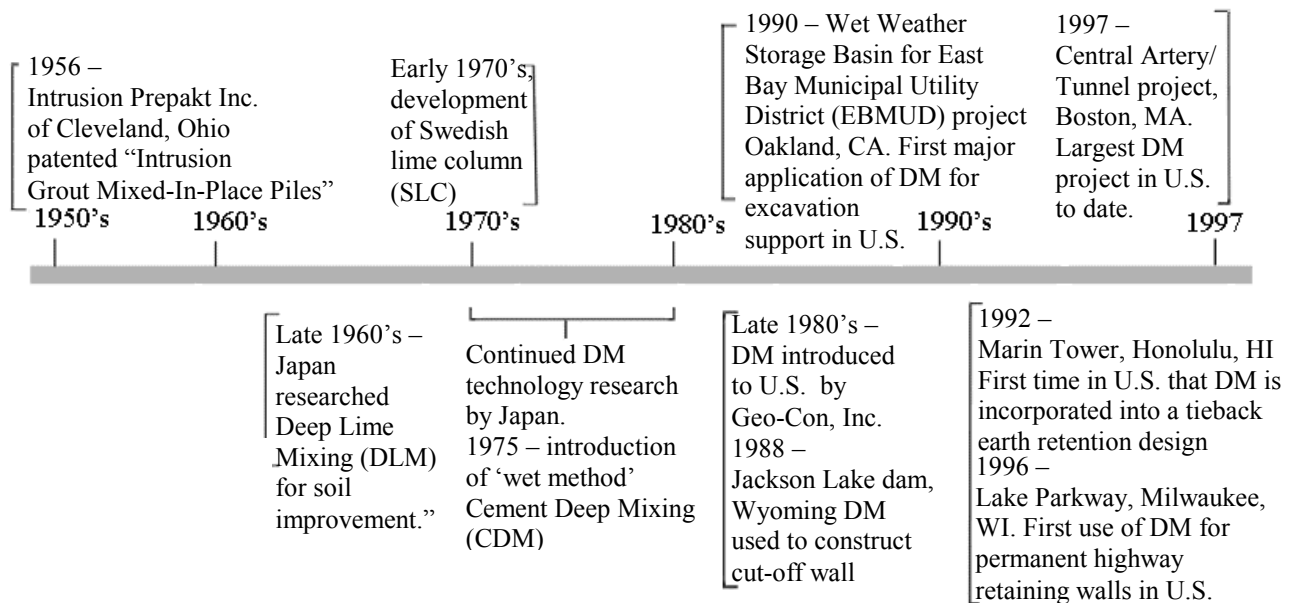

Figure 2 – 1. Deep Mixing for Excavation Support Timeline

2.4 DEEP MIXING METHOD FUNDAMENTALS

Deep mixing has become a general term to describe a number of soil improvement/soil mixing techniques. The Federal Highway Administration (FHWA) has suggested these techniques be classified base on 1) method of additive injection (i.e. dry vs. wet injection), 2) method by which additive is mixed (i.e. high pressure jet or rotary/mechanical energy), and 3) the location of the mixing tool/paddles (i.e. along a portion or at the end of the drilling rods).

Although there are a variety of DM techniques, the most common method of deep mixing for excavations involves overlapped soil cement columns that are either installed using a multi-auger rotary shaft or a drilling tool. The stabilizing agent is usually a slurry mixture of cement, water, and sometimes bentonite. The material resulting from mixing small amounts of cement

has the advantage of improved strength and stiffness. Figure 2 – 2 gives examples values of the strengths of soil, soil cement and concrete.

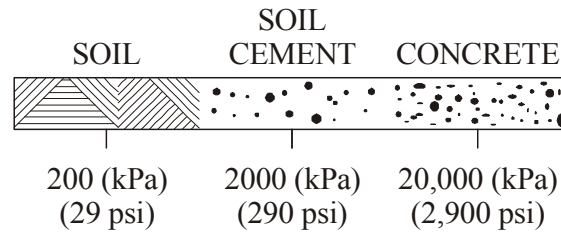

Figure 2 – 2. Strength Comparisons (Typical values)

As described by McGinn and O'Rourke (2003), the Fort Point Channel DM project used three different water cement (w/c = weight of water / weight of cement) ratios (0.7, 0.8, and 0.9) and five different cement factors (CF) of Portland Type I/II cement (2.2, 2.3, 2.5, 2.6 and 2.9 kN/m^3) throughout the duration of the project. Analysis of the unconfined compressive test results showed a statistically significant relationship between increased compressive strength and rising w/c and CF . The unconfined compressive strength of soil cement increased by a factor of 2.5 as CF increased from 1.93 to 2.91 kN/m^3 for a w/c = 0.7. Improved mixing and blending of cement with in situ soils allowed for increased water content in the field contributing to a more homogenous soil cement product with increased compressive strength. McGinn and O'Rourke (2003) concluded that a reduction of the cement factor by increasing water content allowed for significant cost savings. Increasing w/c also delayed set time for soil cement allowing for additional flexibility in installation of reinforcement. One drawback to increased water content was the increased volume of spoils (unused soil cement cuttings) which required additional transportation and disposal.

As described by consultant experience and various publications, the typical arrangement of soil cement columns for excavation support is shown in Figure 2 – 3. Wide flange beams are inserted into the soil cement before curing to resist lateral forces and bending moments. Typically, a H-beam spacing of 1 to 1.5 m (3 to 5 ft) and a soil cement compressive strength of 0.7 to 1.0 Mpa (100 to 150 psi) is adequate to resist these forces (Andromalos and Bahner, 2003).

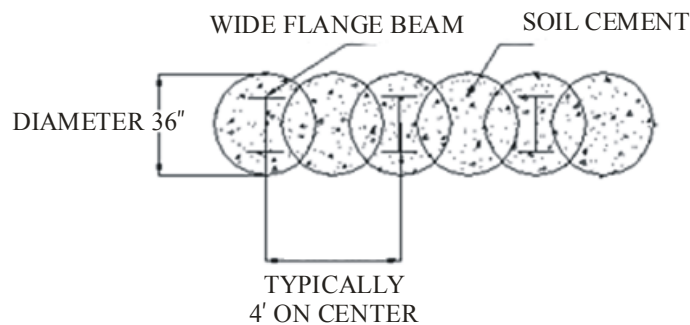

Figure 2 – 3. Typical Arrangement of Soil Cement Columns

Figure 2 – 4 presents a typical soil cement excavation support wall. The soil cement column faces are shaved off to expose the steel reinforcement beams to which walers and tiebacks are connected when used. The steel skeleton system provides structural resistance, while the soil cement columns ensure water tightness and lateral support.



Figure 2 – 4. Soil Cement Excavation Support Wall
(Picture from Schnabel Foundation Company, www.schnabel.com)

The main differences between the construction of a secant pile wall and a DM wall are the materials and the type of equipment used for installation. Secant walls use single auger drilling equipment for the installation and are created from lean concrete. Soil cement walls use multiple auger equipment and consist of in situ soil and cement. The use of lean concrete for secant piles allows the piles to remain soft enough for the drilling and interlocking of the adjacent reinforced piles (McNab, 2002). Steel beams are vibrated into place shortly after the installation of soil cement piles for reinforcement. The faces of the secant piles are shaved off in order to present a flatter surface for the concrete to be formed and allow for the attachment of anchors (McNab, 2002). Figure 2 – 5 depicts the finished soil cement excavation support for the Hermann Hospital, Houston, TX project.



Figure 2 – 5. Hermann Hospital, Houston, TX Excavation (Picture from Schnabel Foundation Company, www.schnabel.com)

2.5 ADVANTAGES OF DEEP MIXING METHOD FOR EXCAVATION SUPPORT

There are many advantages of DM compared to other soil improvement methods and traditional techniques. Traditional techniques for excavation support are compared in Table 1 – 1).

Table 1 – 1, Table 1 – 2 and Table 1 – 3. The placement of DM columns causes little disturbance to surrounding soil, therefore, allowing installation close to an adjacent building's foundation. Unlike driving sheet piles, DM construction generates low vibration and noise pollution. The construction is also typically faster than other traditional methods. One advantage over slurry (diaphragm) walls is a decrease in the volume of spoils generated.

The ability to create soil cement columns to stabilize the base against deep rotational failure is also an important advantage. Soil cement buttresses are used to stabilize deep excavations and improve bearing capacity, prevent deep rotational failures and decrease ground deformation. The main advantage of DM for excavation support is that steel wide flange beams, which are efficient in bending, can be placed in the soil cement columns as reinforcement. The strength of the soil cement columns can be changed based on project requirements by varying the ratio of cement and water to the in situ soil. This allows the designer to control deformations through soil cement specifications and system stiffness (see Section 6.12). Due to advances in mixing equipment, real-time monitoring, and alignment control, deep mixing has become an efficient method for excavation support.

2.6 LIMITATIONS OF DEEP MIXING METHOD FOR EXCAVATION SUPPORT

DM, as with most excavation support methods, has limited use in soils containing boulders and sites with multiple underground obstructions such as utilities, subways, or other underground structures. Due to the required equipment, the project must also have clearance for overhead drilling. Although the depth of DM is based on limitations of drilling and mixing equipment, the current technology allows construction to as much as 60 m (196.8 ft) of depth.

CHAPTER 3

GEOMATERIAL DESIGN

3.1 INTRODUCTION

This chapter will discuss the properties of soil cement and emphasize how different factors can affect the soil cement properties. The main focus of the geomaterial design is that a quality product (continuously mixed soil cement with no openings or joints) must be achieved to satisfy the minimum strength and other design requirements. Although the DM specialty contractor often determines the mix design, it is important for the design engineer to understand the factors contributing to the strength and permeability of the soil cement.

3.2 FACTORS AFFECTING STRENGTH OF SOIL CEMENT

A number of factors influence the strength of the resulting soil cement column. Both the properties of the in situ soil and stabilizing agent strongly affect the strength of the treated soil (Terashi, 1997) as outlined in Table 3 – 1.

Table 3 – 1. Factors Affecting Soil Cement Strength (After Terashi, 1997)

I. Characteristics of stabilizing agent	<ol style="list-style-type: none"> 1. Type of stabilizing agent 2. Quality 3. Mixing water and additives
II. Characteristics and conditions of soil (especially important for clays)	<ol style="list-style-type: none"> 1. Physical chemical and mineralogical properties of soil 2. Organic content 3. pH of pore water 4. Water content
III. Mixing conditions	<ol style="list-style-type: none"> 1. Degree of mixing 2. Timing of mixing/re-mixing 3. Quantity of stabilizing agent
IV. Curing conditions	<ol style="list-style-type: none"> 1. Temperature 2. Curing time 3. Humidity 4. Wetting and drying/freezing and thawing, etc.

Although Categories II (in situ soil) and IV (curing conditions) contain factors that are not easily changed or controlled at the site, Categories I (stabilizing agent) and III (mixing conditions) are relatively easy to alter. By controlling the degree of mixing, penetration/withdrawal and quantity of stabilizing agent, a quality homogenous soil cement column can be created. To satisfy the design requirements, the creation of a quality product that is continuously mixed containing no openings or joints should be insured. Quality assessment will be discussed in greater detail in Chapter 9.

3.3 SELECTION OF MATERIAL PROPERTIES

The material properties of the DM walls are specified based on the design and performance criteria required for the project. Unconfined compression strength specified for an excavation support cutoff wall is usually greater than 700 kPa (100 psi) and hydraulic conductivity usually ranges from 10^{-5} to 10^{-6} cm/s (4×10^{-6} to 4×10^{-7} in/s) (Taki and Yang, 1991).

3.3.1 STRENGTH

Unconfined compression tests are usually conducted on specimens prepared from wet grab samples in the laboratory and specimens trimmed from core samples. As described by McGinn and O'Rourke (2003), a database of unconfined compression tests was compiled for the Fort Point Channel deep mixing project. Statistical analysis was conducted to find trends. Tests results demonstrated that the unconfined compressive strength data could be characterized by a lognormal distribution to a 5% significance level. Although the data was for a specific location, cement factor and water content, there was considerable variability in the unconfined compressive strength results. Variations in soil conditions, mixing process and sampling procedures contributed to the variability of data. Bias in the data reflected in both lower unit weight and higher confined compressive strength for the wet grab samples compared with the core samples was determined to be due to the relatively small opening of the wet grab sampler. The small opening tended to block untreated soil or poorly mixed samples. Table 3 – 2 summarizes the data collected for the various samples and tests.

Table 3 – 2. Summary of Unconfined and UU Compressive Strength (After McGinn and O'Rourke, 2003)

Sample Description	Number of Samples	Arithmetic Mean (MPa)	Median (MPa)	Coefficient of Variation
All Core Samples	823	2.68	1.59	1.30
Core Samples with CF = 2.91 kN/m ³ and w/c = 0.7	322	2.34	1.17	1.46
Core Samples with CF = 2.32 kN/m ² and w/c = 0.9	133	2.84	2.00	0.85
UU Samples	26	2.04	1.65	0.60
<u>Pressuremeter Tests:</u>				
Log Pressure/Strain	22	2.57	2.62	0.46
Inversion	22	2.51	2.48	0.61

Figure 3 – 1 provides histograms of unconfined compressive strength data for 150–mm–diameter and 75–mm–diameter soil cement samples. As described by O'Rourke et al. (1997), there is not a statistically significant difference in the mean and variance of the two data sets, implying that the smaller size specimens are suitable for strength assessment and quality control decisions. A considerable amount of variability exists in both data sets with coefficients of variation (defined as the ratio of standard deviation, s , to the mean, \bar{x}) of 0.49 and 0.47 for the 150–mm and 75–mm specimens, respectively.

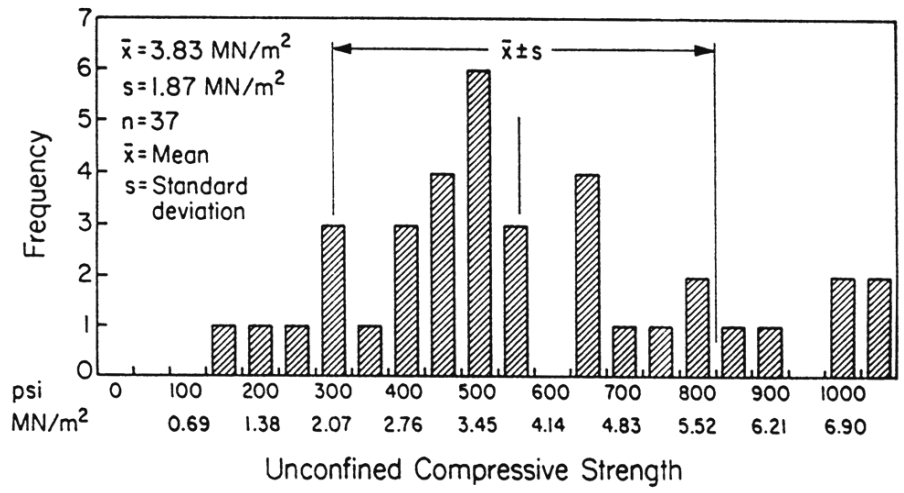

a) 150-mm-Diameter

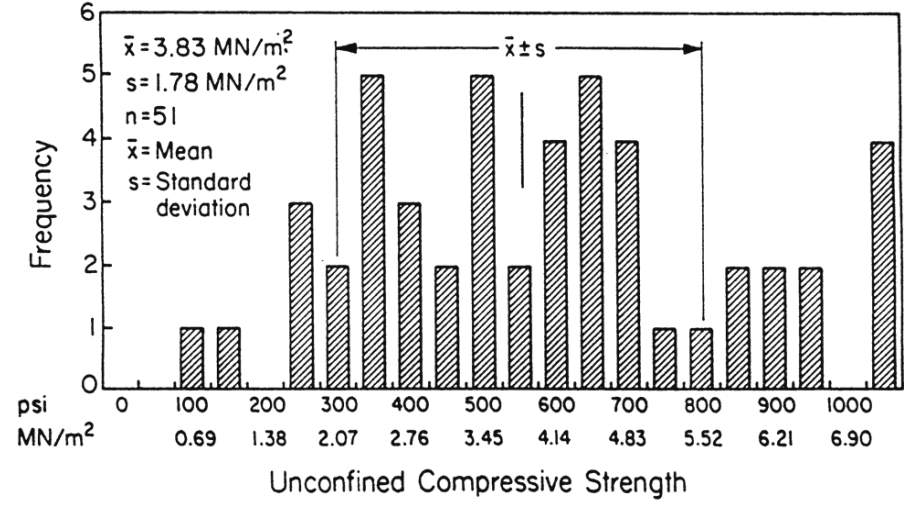

b) 75-mm-Diameter

Figure 3 – 1. Histogram of Soil Cement Unconfined Compressive Strengths (After O'Rourke et al, 1997)

The soil type greatly influences the strength of the soil cement. Figure 3 – 2 compares the unconfined compressive strengths, q_u , at 28 days resulting from 21 different soils in Japan stabilized by cement content (aw) of 20% (Niina et al., 1981). The cement content, aw , is defined by the ratio of dry weight of cement to the dry weight of the original soil. In Figure 3 – 2, the physical and chemical properties of the in situ soils are also shown.

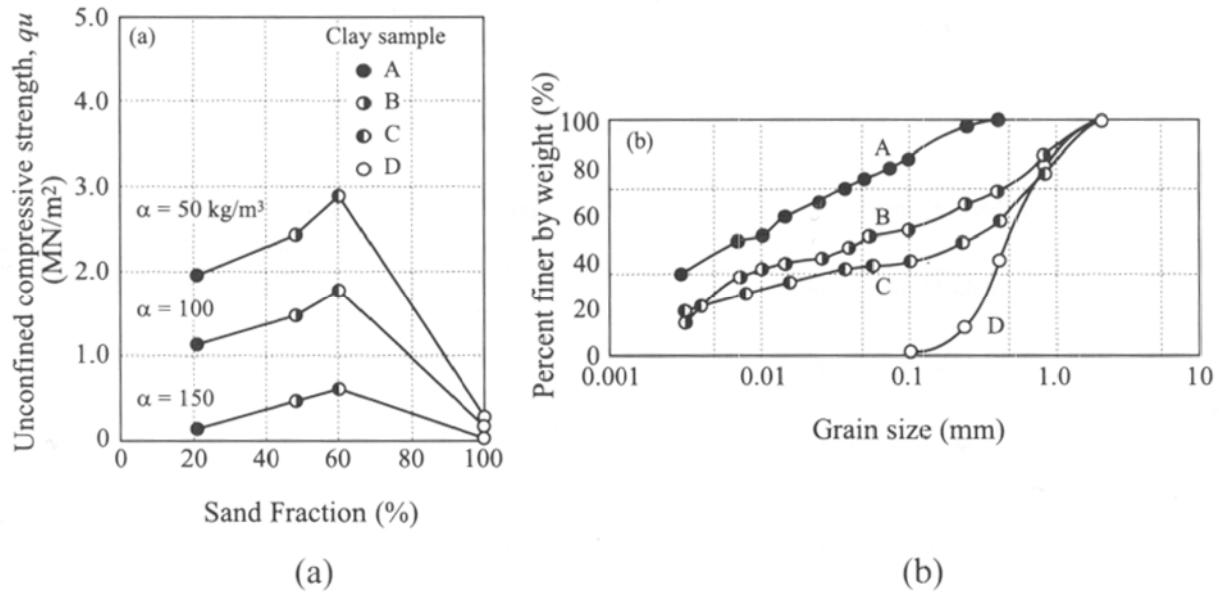

Figure 3 – 3. Effect of Grain Size Distribution on Strength (After Coastal Development Institute of Technology (eds.), 2002)

3.3.2 PERMEABILITY

Soil type, quantity of cement, water cement ratio, age, and injection ratio of cement affect the permeability of the soil cement (Taki and Yang, 1991). Figure 3 – 4 presents results of laboratory permeability tests from a man-made island project as well as the ranges for field wet samples of three different DM projects.

The permeability of the soil cement is also affected by pore size distribution (Kunito et al., 1988). Figure 3 – 5 illustrates the correlation between the pore size distribution and permeability of the soil cement. The higher percentage of fine pores reduces the soil cement permeability.

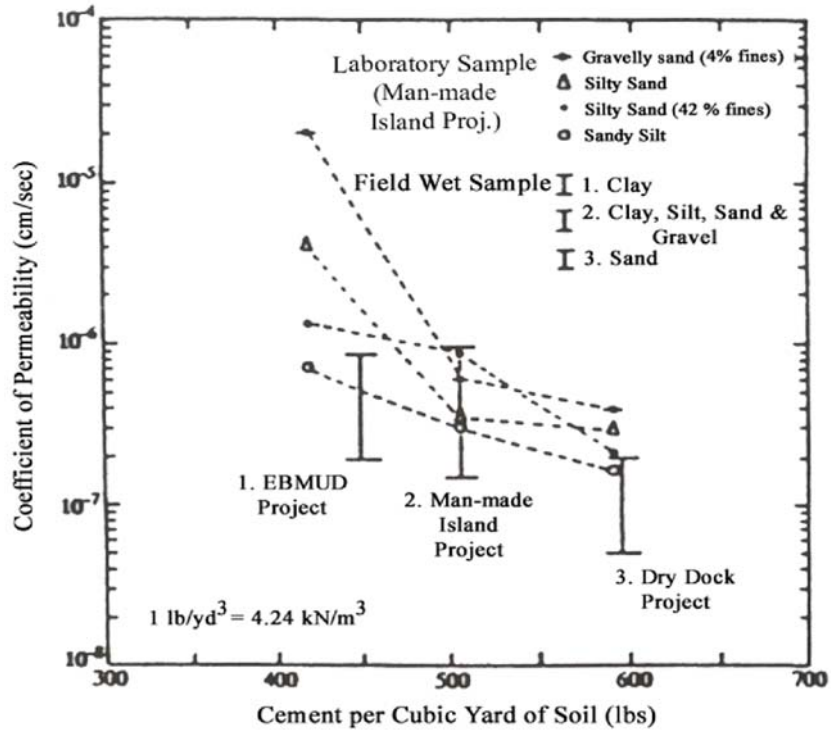

Figure 3 – 4. Permeability of Soil Cement (After Taki and Yang, 1991)

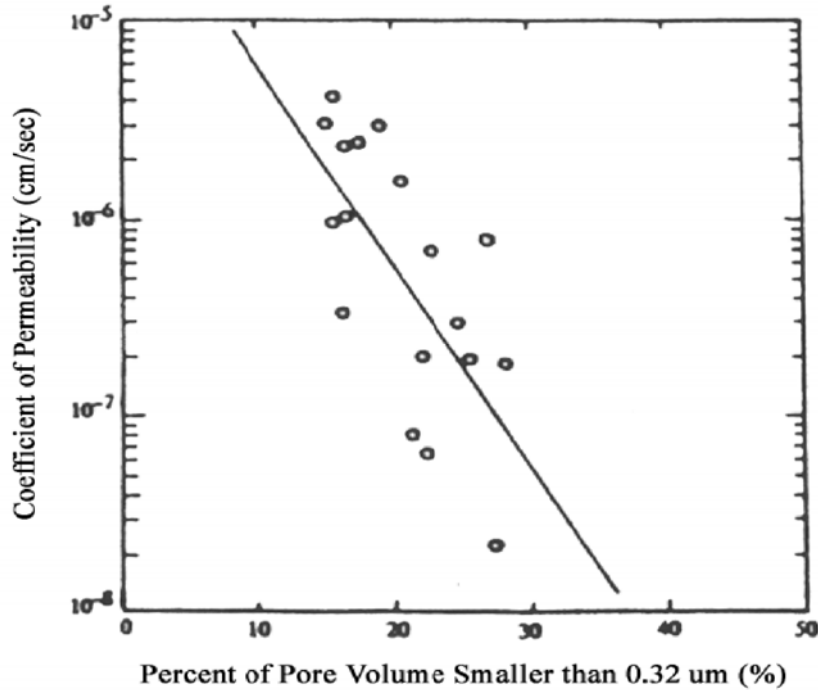

Figure 3 – 5. Correlation between Permeability and Pore Size Distribution (After Taki and Yang, 1991)

3.3.3 MODULUS

The modulus of a soil is a complex parameter which requires a precise definition when quoted. The modulus depends on the stress level, the strain level, the rate of loading, the number of cycles and other factors. The range of Young's moduli in soils is approximately 5 to 1000 MPa. Table 3 – 3 presents the approximate ranges of various materials.

The addition of cement grout in soils increases the modulus but this increase is not well documented. Briaud et al. (2000) present results from a full scale, extensively instrumented DM project at Texas A&M University (Figure 3 – 6). The equation below may be retained as a conservative one:

$$E_{\text{Soil/Grout}} (\text{kPa}) = 12,900 (f_e' (\text{kPa}))^{0.41} \quad (3-1)$$

where:

f_e' is the unconfined compressive strength.

O'Rourke et al. (1997) suggest estimating the modulus of soil cement as

$$E = 100 q_u \quad (3-2)$$

where:

q_u is the unconfined compressive strength.

Table 3 – 3. Young's Moduli (After Briaud et al., 2000)

Material	Range of Moduli
Steel	200,000 MPa
Concrete	20,000 MPa
Wood, Plastic	~ 13,000 MPa
Rock	2,00 to 30,000 MPa
Soil/Grout	100 to 1000 MPa
Soil	5 to 1000 Mpa
Mayonnaise	~0.5 MPa

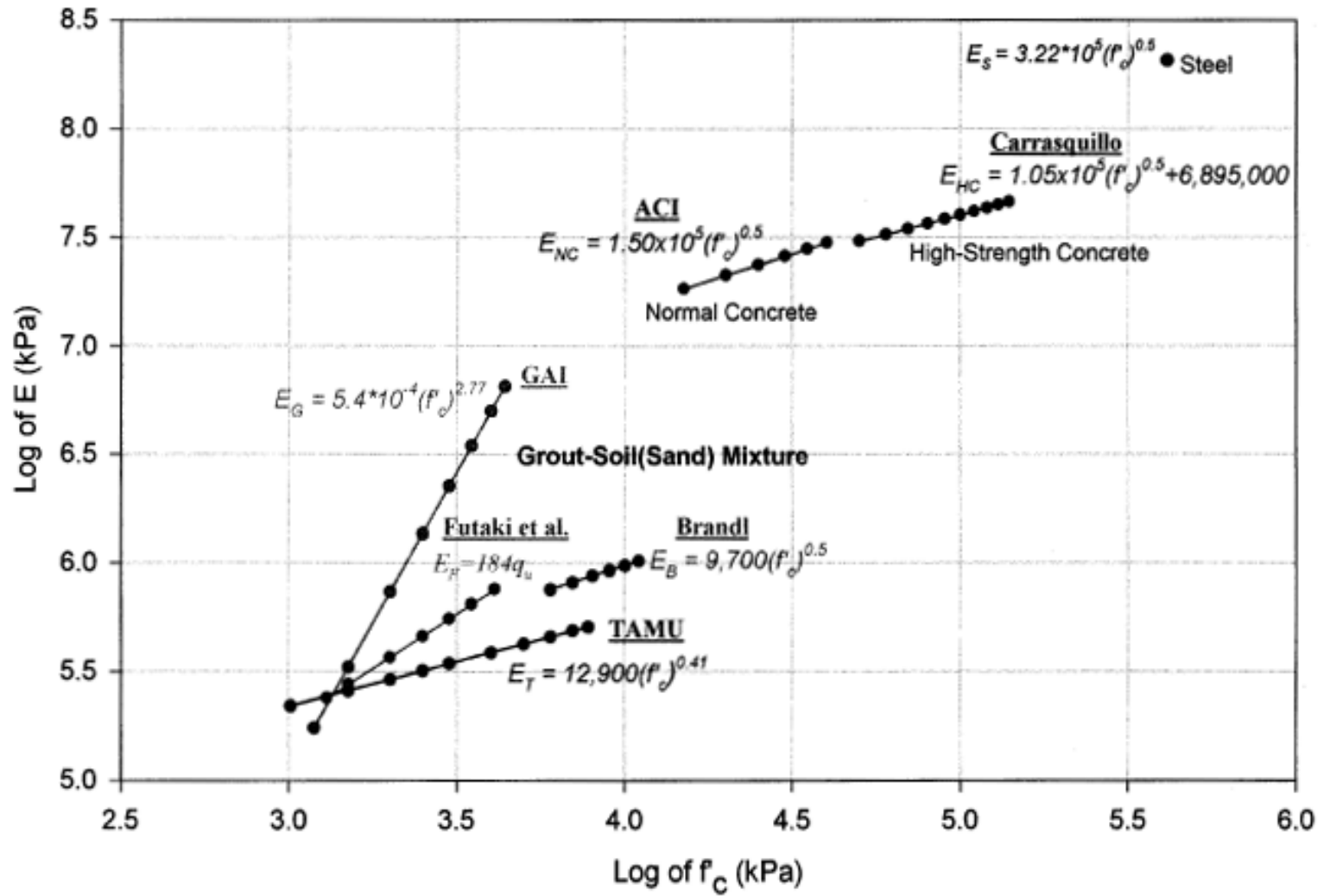

Figure 3 – 6. Correlation of Young's Modulus and Strength (After Briaud et al., 2000)

Figure 3 – 7 shows secant shear modulus, G_{sec} , as a function of radial strain for soil cement data gathered during the Fort Point Channel (FPC) deep mixing project (McGinn and O'Rourke, 2003). The plot was derived from pressuremeter test data, shear wave velocity test results, plate load and laboratory unconfined compression tests. The lower and upper bounds were generated from pressuremeter tests at 15–30 m and below 30 m, respectively. Crosshole and downhole shear wave velocity measurements were used to determine the range of G_{max} . Plate load tests were used to estimate the shear modulus assuming that the plate load dimensionless displacement is roughly correlated with the pressuremeter radial strain.

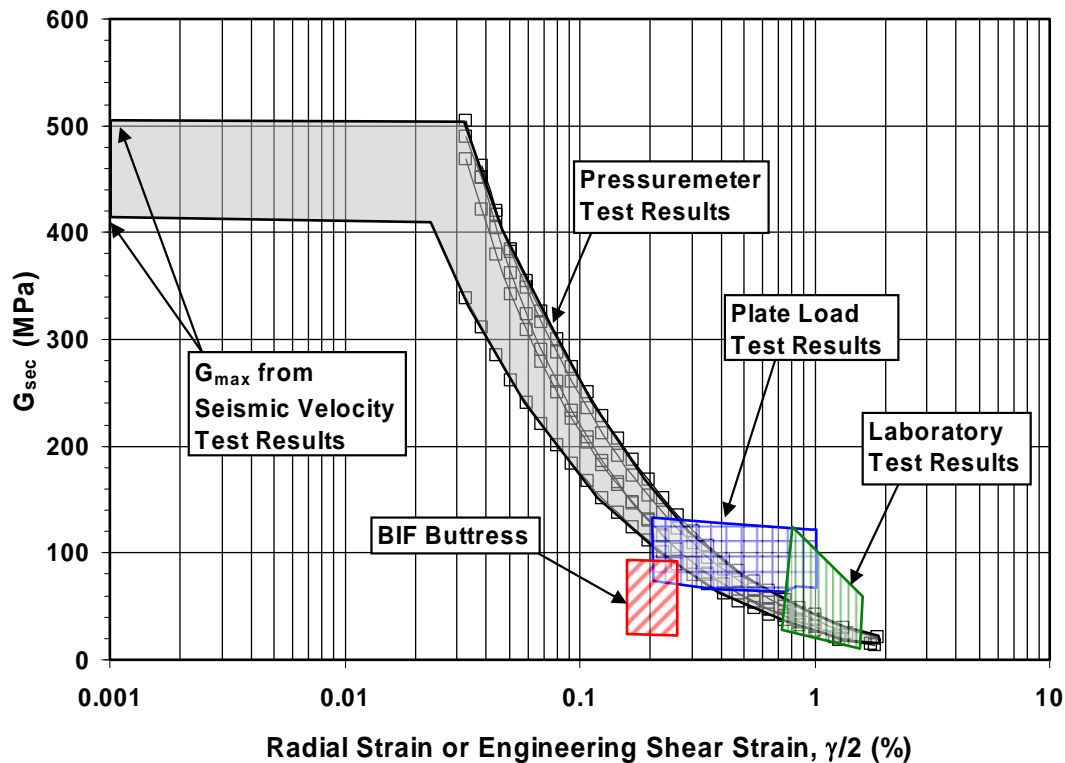

Figure 3 – 7. Shear Modulus as a Function of Radial and Engineering Strain for FPC Soil Mix (After McGinn and O'Rourke, 2003)

3.4 MIX DESIGN

The required engineering properties of the soil cement wall govern the mix design. The engineer usually specifies the strength and permeability required and provides provisions to verify the continuity and homogeneity of the deep mixed column. The mix design is usually determined by the contractor specializing in DM technology. The final mix design takes into consideration the in situ soil, type of equipment used, installation procedure, required quality, and economics of the project (Taki and Yang, 1991). For the Fort Point Channel deep mixing project during the pre-construction soil cement testing program, eight mixes were used for the clay ranging in cement factor from 1.12 to 4.65 kN/m³. For the organic silt, three mixes cement factor ranged

from 0.94 to 2.14 kN/m³. A water content ratio equal to 1.25 (potable water to Type II Portland cement) was used for the each of the mixes (McGinn and O'Rourke, 2003).

CHAPTER 4

CASE HISTORIES IN DEEP MIXING FOR EXCAVATION SUPPORT

4.1 INTRODUCTION

Case histories were selected to highlight issues arising from the use of DM for excavation support. Historically relevant projects were chosen as well as unique applications of deep mixing to traditional construction problems. Each case history will show an example of deep soil mixing use, construction, design considerations used in the project and will compare the performance of the final project.

4.2 CASE HISTORY 1 – EBMUD STORAGE BASIN, OAKLAND, CA

The East Bay Municipal Utility District's (EBMUD) Wet Weather Storage Basin was the first major application of deep soil mixing for excavation support in the United States constructed in 1990 (Taki and Yang, 1991). This case, designed in 1988, was probably either the first or one of the first excavations designed specifically using deformation control methodologies.

EBMUD Wet Weather Storage Basin required an excavation of 82 m by 67 m (270 ft by 219 ft) in footprint, and 12 m to 14 m (40 to 45 ft) deep. The site was located within 9 m (30 ft) of an existing effluent channel. The channel had to remain operational and required a shoring system to minimize lateral movement and settlement. The excavation was also within 10.7 to 15 m (35 to 49 ft) of other facilities, including an existing energy building and multiple above ground storage tanks. Impacts to the adjacent structures and settlement due to dewatering were of major concern (Taki and Yang, 1991; Koutsoftas, 1999).

4.2.1 Site conditions

The surface layer is a very loose sandy fill approximately 2.4 m (7.8 ft) thick. The sand fill is underlain by a layer of soft to medium stiff, highly plastic silty clay also known as San Francisco Bay Mud, which extends to a depth of 9 m (29.5 ft). In some of the site, thin very loose marine sand lenses are present between the layers of Bay Mud. A layer of very stiff clay, extending to depths of 35 m (115 ft) and greater, is directly below the Bay Mud. The water table is approximately 1.5 m (5 ft) below the surface.

4.2.2 Design

The excavation was designed specifically for deformation control. Shoring specifications required the maximum lateral deformations should not exceed 70 mm (2.76 in). A minimum secant modulus of the wall in combination with maximum strut spacing of 3 m (10 ft) was specified, but the specifications allowed for other alternatives. A soil cement mixed wall design was chosen to function as both excavation support and groundwater control. The 0.6 meter (1.97 ft) thick soil cement wall is reinforced by the W21x57 wide-flange beams spaced 0.9 m (3 ft) in alternating soil cement columns. The internal bracing system consisted of three levels with average strut spacing of 3.66 m (12 ft). An unconfined compressive strength of 427 kPa (62 psi) was determined from stress analysis of the soil cement column using the lateral pressure specified. A factor of safety of 2 was used.

4.2.3 Construction

Construction started in April 1990 on the DM wall using three-axis soil mixing equipment. A total of 5797 m² (62,400 ft²) of wall were completed in June 1990. The average daily construction rate was approximately 139 m² (1,500 ft²).

4.2.4 Performance

The results of unconfined compressive test and permeability test on field wet samples indicated the soil cement met the specified requirements. Inclometers installed behind the support wall reported a maximum displacement of 57 mm (2.24 in), as shown in Figure 4 – 1.

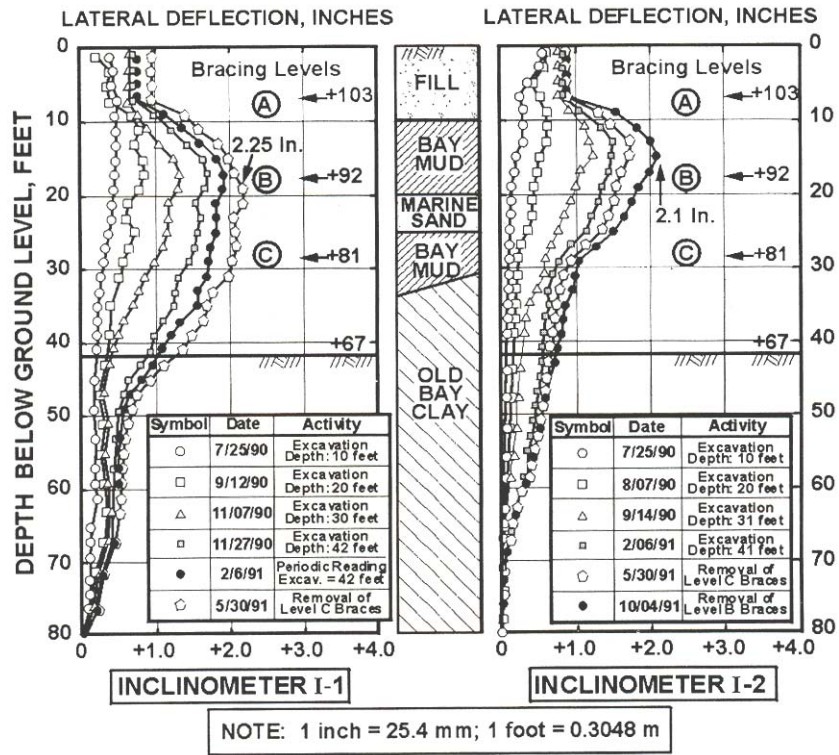

Figure 4 – 1. Lateral Deformation Profiles (After Koutsoftas, 1999)

4.3 CASE HISTORY 2 – LAKE PARKWAY PROJECT, MILWAUKEE, WI

Prior to 1996, deep mixing had been used in the United States for only groundwater cutoff and temporary earth retention. The Lake Parkway project was the first time deep mixing technology was incorporated in a permanent highway retaining wall design. The wall utilized a combination of tieback soldier beam/deep mixed cutoff wall system with an architectural concrete facing.

The Lake Parkway project required the construction of a depressed roadway located in a railway/utility corridor of a residential area (Figure 4 – 2). The roadway was 912 m (29.5 ft) long and in some areas as much as 9 m (29.5 ft) below grade. The alignment extended a distance of approximately 4.8 km (2.98 miles) from Interstate Highway 794 to E. Layton Ave. along north side of General Mitchell International Airport. Construction considerations included existing rail lines, an existing street, an overhead high voltage electrical line, buried high-pressure sludge, sewer and water lines. One major concern was a 2100 mm (82.7 inch) water line that carried most of Milwaukee’s drinking water. The utilities had to be either avoided or grouted to prevent potential leakage paths if they passed through the cut off walls (Anderson, 1998; Bahner and Naguib, 1998; Andromalos and Bahner, 2003).



Figure 4 – 2. Lake Parkway Project (Picture from Schnabel Foundation Company, www.schnabel.com)

4.3.1 Site Conditions

The site is underlain by layers of silt, silty clay, and clean fine sands to depths of 4.6 m to 18.3 m (15.1 to 60 ft) below existing grade. Stiff to hard silty clay/clayey silt with interbedded layers of medium dense to dense silty sand and silt underlie the upper layers. The ground water is typically at a depth of 2.4 m (7.87 ft) below the ground surface.

4.3.2 Design

The design criteria included 1) a minimum design life of 75 years; 2) a maximum groundwater infiltration rate of $6.2 \text{ m}^3/\text{day}/\text{m}$ (500 gpd/lf); 3) a maximum groundwater table drop of 152 mm (6 in) at a distance of 15 m (49.2 ft) behind the cutoff wall; 4) a maximum lateral wall movements not exceeding 258 mm (10.2 in); and 5) a minimum facing wall thickness of 610 mm (24 in) at the base of the wall. Sheet pile walls were determined to be unacceptable due to the potential for leakage through joints. SEEP/W, a 2D FEM flow analysis, was used to determine the depths of the cutoff walls. The expected groundwater inflow was calculated to be 2.48 to 30 L/day/m (0.2 to 2.4 gpd/lf) and drawdown was estimated on the order of 25 mm (1 inch) for wall permeabilities of 10^{-9} m/s to 10^{-8} m/s were found. When a wall permeability of 10^{-7} m/s was assumed, the inflow rate increased to 62 to 86 L/day/m (5 to 15 gpd/lf) with drawdowns of 76 to 229 mm (2.99 to 9.01 in). The cutoff walls were keyed into the shallow till layer south of St. Francis Avenue and penetrated the shallower low permeability sediments north of St. Francis Avenue. Figure 4 – 3 illustrates a typical section of the wall.

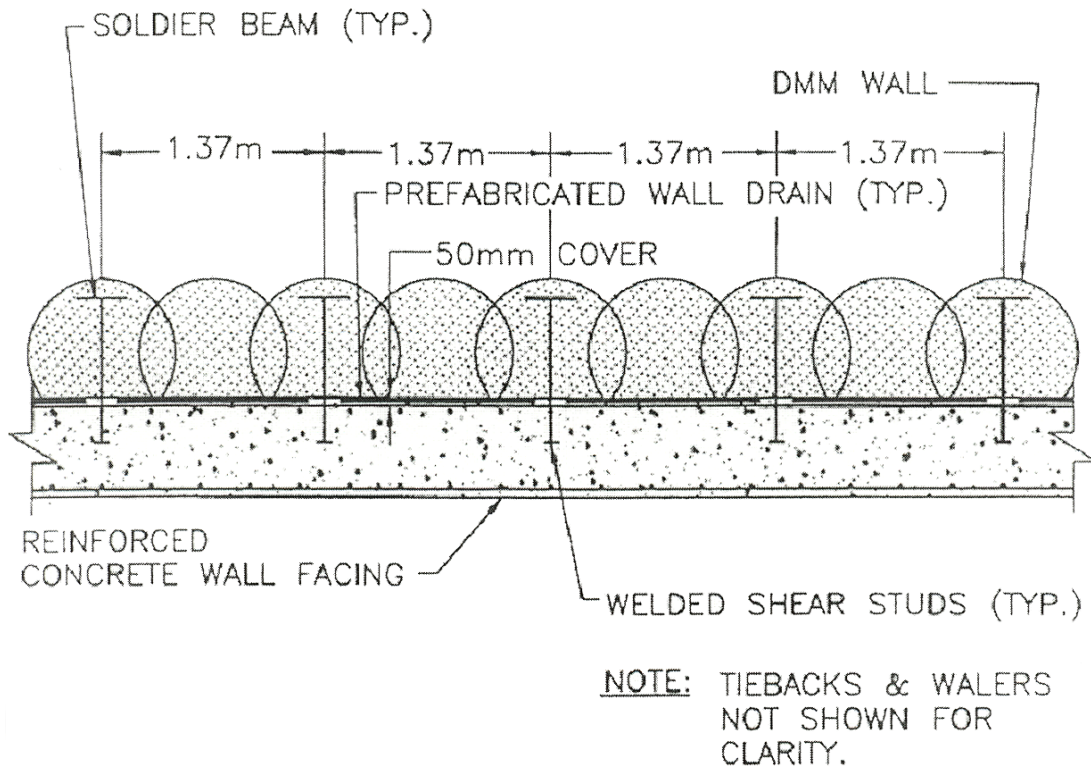

Figure 4 – 3. Typical Wall Plan (After Bahner and Naguib, 1998)

4.3.3 Construction

The construction of the excavation was conducted in stages to maintain traffic flow. The cutoff walls were constructed first. Then, the traffic was diverted to complete the second stage,

construction of the structural support walls. Following mixing, steel soldier beams were installed at 1.37 m (4.5 ft) spacing. A total of 1.2 m (3.94 ft) of cover (0.6 m (1.97 ft) of concrete wall facing and 0.6 m (1.97 ft) thick DM wall) was used as frost protection on the walls that extend below the ground water level at depth of 2.4 m (7.87 ft). In excess of 20,900 m² (224,965 ft²) of DM cutoff wall was installed. Three-day cylinders tests resulted in typically 2 to 4 times the design strength and flexible wall permeability tests determined the hydraulic conductivity ranged from 10⁻⁸ and 9x10⁻¹⁰ m/s.

4.3.4 Performance

Three inclinometer readings were taken and the measurements show that the lateral movement was below the 25 mm (0.98 in) maximum allowed lateral movement limit. During construction, the excavation support wall was exposed to repeated freezing and thawing conditions. Superficial crumbing occurred at some of the exposed areas. In areas with the most pronounced deterioration, shotcrete was used as replacement cover.

4.4 CASE HISTORY 3 – CENTRAL ARTERY/TUNNEL PROJECT: BIRD ISLAND FLATS, BOSTON, MA

The Central Artery/Tunnel project is the largest single contract deep mixing project in the Western Hemisphere to date with approximately 420,000 m³ of soil stabilization performed (Jakiel, 2000). DM was used to protect against deep rotational failure of the clay, control ground deformation and provide a stable base for construction and permanent structures.

The CA/T project (Figure 4 – 4) located at Fort Point Channel (FPC) required the design of a cut-and-cover tunnel to connect the Logan International Airport and the immersed twin steel tube tunnel crossing the Boston Harbor (Davidson, et. al., 1991; Yang and Takeshima, 1994; McGinn and O'Rourke, 2003). The excavation was 1,128 m (3,701 ft) long ranging in depth from 12.5 to 26 m (41 to 85.3 ft). The excavation was supported by a combination of DM walls and concrete slurry walls.



Figure 4 – 4. CA/T Project, Boston, MA
(Picture from Schnabel Foundation Company, www.schnabel.com)

4.4.1 Site Conditions

The subsurface conditions, from the surface down, consisted of fill, organic deposits, marine deposits, glaciomarine deposits, above bedrock. The fill material consisted of granular fill, miscellaneous fill and cohesive fill. The organic deposits varied in thickness from 1 to 3 m (3.28 to 9.84 ft) consisting of organic silt with sand, silt and clay. The marine deposits were Boston Blue Clay, with lenses of sand and silt. The upper glaciomarine deposit consists of silt with little sand, clay, gravel and cobbles. The lower glaciomarine deposit was a silt with little gravel, sand, clay, cobbles, and boulders. The primary distinctions between the two deposits are the cohesion and N-values.

4.4.2 Design

The excavation support system consisted of four to five tiers of tieback anchors and was reinforced with W21x50 H-piles spaced at 1.2 m (4 ft) intervals. The soil cement was designed with an unconfined compressive strength of 620 kPa (89.9 psi) to resist the lateral stresses (Yang and Takeshima, 1994).

4.4.3 Construction

Because the subsurface conditions varied, the installation procedures of the DM wall also varied. The construction can be grouped in three zones: (1) Zone A – Thick Glaciomarine Deposit; (2) Zone B– Thick Fill Deposits; and (3) Zone C – Thick Marine Deposits. In Zone A, the DM wall extended to a depth of 28 m (91.9 ft) into the glaciomarine deposits. In Zone B, – the depth of the wall was a maximum of 25 m (82 ft) and the profile contained granular fill, miscellaneous fill, and cohesive fill. Zone C consists of Boston Blue Clay to a maximum depth of 30 m (98.4 ft) overlaid by 6 m (19.7 ft) of fills and 1 to 2 m (3.28 to 6.56 ft) of organic deposits. For DM construction in this zone, a large quantity of slurry was used. Over 37,180 m² (400,202 ft²) of soil cement was constructed this project

4.4.4 Performance

The mean unit weight of 775 core samples and 3319 wet grab samples were 16.3 kN/m³ and 15.2 kN/m³, respectively. The mean unconfined compressive strengths for 823 core samples and 3545 wet grab samples were 2.68 MPa and 3.95 MPa, respectively (McGinn and O'Rourke, 2003). The maximum horizontal wall displacements recorded were 64 mm. This recording was measured at an inclinometer located directly behind (within 152 mm) of the W14x82 section of the wall. The dredging procedures caused tolerable lateral deflections.

4.5 CASE HISTORY 4 – HONOLULU EXCAVATION

Before 1992, deep mixing technology was used in the United States mainly for ground water control beneath dams and along levees. Deep mixing technology could be adapted for application in earth retention systems in condition with highly permeable soil deposits and a high ground water table. Such conditions existed at the Honolulu site. Total de-watering of the excavation was not an option because of the proximity of the harbor, approximately 30 m (100 ft) away. Sheet pile walls were not feasible due to the dense cemented coralline sands and gravels. The deep soil mixing method was selected to create cutoff walls for groundwater control (Yang and Takeshima, 1994).

Marin Tower located in the city of Honolulu, Hawaii (Figure 4 – 5), consists of a 28-story tower with a two level subsurface parking garage on a site with highly permeable coral ridge and coralline deposits (Yang, 1994; Yang and Takeshima, 1994).



Figure 4 – 5. Marin Tower, Honolulu, HI Project Site
(Picture from Schnabel Foundation Company, www.schnabel.com)

4.5.1 Site Conditions

The site is underlain by loose, highly permeable coralline deposits, coral reef, reef detritus materials, and alluvium deposits. The upper coral reef approximately 3 m (9.8 ft) thick consists of hard coralline limestone with cavities. Detritus materials varying from depths of 4 to 35 m (13 to 115 ft) consist of medium dense sandy coral gravel interbedded with layers of loose to medium dense coral sand. Thin layers of alluvium were occasionally encountered. Located between 15 and 24 m (49 and 79 ft), the upper alluvium deposits consist of clayey silt and sand layers. The lower alluvium deposits, extending to a depth of 47 m (154 ft), consist of layers of sand, basaltic gravel, basalt gravel, basalt boulders and cobbles. One exception was found in the

case of a boring location where a basalt rock formation was encountered at a depth of 40 m (131 ft). The observed groundwater level fluctuated with tidal changes between 3 to 6 m (9.8 to 19.4 ft) below the ground surface (Yang and Takeshima, 1994).

4.5.2 Design

The ideal installation of the soil cement walls should key into a low permeability layer in both horizontal and vertical directions to effectively control ground water. Due to the varying deposits, this was not possible. Therefore, a partial cutoff scheme was developed. The wall extended to an average depth of 14 m (45.9 ft) to control the lateral groundwater flow and to reduce the amount of vertical flow through the increased length of the seepage path. To resist lateral pressures, H-piles were included in every other soil cement column. A total embedment of 6.4 m (20 ft) embedment was required. 3.4 m (11.2 ft) of the embedment was reinforced with H-piles for stability of the toe. The additional 3 m (9.8 ft) of the embedment was not reinforced and served as a seepage cutoff wall.

4.5.3 Construction

The deep mixing wall was installed to a total depth of 21.3 m (69.9 ft). The total excavation depth was 9.1 m (30 ft) with 6 m (20 ft) below the water table. H-piles were set in the soil mix, and tiebacks were installed to support the soil and resist hydrostatic water pressures. A 55 cm (21.7 in) diameter three-axis auger was used to install the soil cement columns. No pre-drilling was required through the coral reef. The drilling speed was adjusted to break and grind the coral limestone into gravel size or smaller pieces and for thorough mixing with cement grout. The soil cement mixture produced consisted of particles with sizes ranging from gravel to silt. The unit weight of the soil cement mixture was approximately 1.6 kN/m^3 (10 pcf). In situ water was prevented from entering the soil cement columns because a higher pressures was maintained in the borehole during construction. The soil cement mixture flowed in to fill and stabilize the cavities and prevent further loss of soil-cement mixture. One side of the soil cement columns was shaved off using a backhoe to create a flat surface, as shown in Figure 4 – 6. Mix designs with cement dosages ranging from 300 to 500 kg per cubic meter of in situ soil were used providing 28-day unconfined compressive strengths ranging from 833 to 1431 KPa (8.5 to 14.6 kg/cm^2). A total of eleven dewatering wells were installed of which five were constantly used to control the bottom flow of groundwater. The construction of the basement of the Marin Tower was enabled due to the control of the horizontal flow of groundwater through the use of deep mixing technology. The wall was completed in March, 1994.



Figure 4 – 6. Marin Tower, Honolulu, HI Excavation Support System
(Picture from Schnabel Foundation Company, www.schnabel.com)

4.5.4 Performance

A total of 4,015 m² (4,3217.1 ft²) of soil cement wall was constructed, of which approximately 80% served the dual function of excavation support and groundwater control.

4.6 CASE HISTORY 5 – OAKLAND AIRPORT ROADWAY PROJECT, OAKLAND, CA

The Oakland Airport Roadway project consisted of three grade separation structures at two roadway interchanges and the intersection of a roadway and taxiway (Yang et al., 2001; Yang, 2003). Deep soil mixing was used for foundation improvement, construction of a soil cement gravity retaining wall and groundwater control using two cutoff walls. A block-type gravity structure was constructed at the Air Cargo Road/Taxiway intersection to function both as a permanent retaining structure and temporary shoring. Cutoff walls were used as permanent seepage control and to reduce dewatering requirements during construction.

4.6.1 Site Conditions

The subsurface conditions consist of three strata including artificial fill, Young Bay Mud, and the San Antonio Formation. The artificial fill is generally less than 4.5-m-thick (15 ft) and includes hydraulically placed, dredged, loose or very loose sand materials. Underlying the fill, the Young Bay Mud is soft to very soft silty clay generally less than 3 m (10 ft) deep and is absent in some areas. The San Antonio Formation consists of competent clays and sands. Due to the airport pumping activities, the ground water levels at the site vary from 1.5 m (5 ft) to 3 m (10 ft) below the existing ground surface (Yang, 2003).

4.6.2 Design

The project design is broken into three distinct areas: (1) Doolittle Drive/Airport Cargo Road interchange; (2) Airport Drive/ Air Cargo Road interchange and (3) Air Cargo Road/Taxiway B intersection. A DM cutoff was constructed at the Doolittle Drive/Airport Cargo Road interchange to provide permanent seepage control and to minimize dewatering requirements during construction. The soil beneath the new soil embankment was improved using DM to increase the soil strength and reduce the potential for lateral spreading of the embankment under seismic loading conditions at the Airport Drive/ Air Cargo Road interchange. At the Air Cargo Road/Taxiway B intersection, gravity structure including soil nails for reinforcement was constructed as a permanent retaining structure and as a temporary shoring system during construction. Design criteria limited the permanent lateral deformation of the embankment to 150 mm (0.5 ft) during a design earthquake with a probability of exceedance of 20 percent in 50 years. Permanent ground deformations were evaluated using pseudo-static stability methods, Newmark-type displacement analyses incorporating peak horizontal ground acceleration, and duration of strong ground shaking estimated for the design level event. The cutoff walls were designed for a maximum permanent deformation of about 90 mm (0.33 ft) during a design earthquake with a probability of exceedance of 5 percent in 50 years.

4.6.3 Construction

The construction of the DM gravity wall began in March 2001 and was completed in December 2001 with approximately 34,405 m³ (45,000 yd³) of soil cement. The DM cutoff was at the Airport Drive Undercrossing at Doolittle Drive began in May 2000 and was completed in July 2000. The DM foundation treatment at Airport Drive Overcrossing and Taxiway B Overcrossing at Air Cargo Road began in March and April 2001, respectively. The gravity wall had a minimum width equal to the maximum depth of the excavation during construction and extended to a minimum of 1.22 m (4 ft) below the excavation (Yang, et al., 2001). For additional resistance against sliding, the soil cement panels were keyed into the layer below the gravity wall. Geocomposite drain strips were used to release the water pressure behind the permanent wall facing of the gravity wall. As illustrated in Figure 4 – 7, a DM cutoff wall was incorporated in the center of the soil cement gravity wall and extended beneath the bottom of the gravity wall to reduce the flow seepage under the gravity wall (Yang 2003).

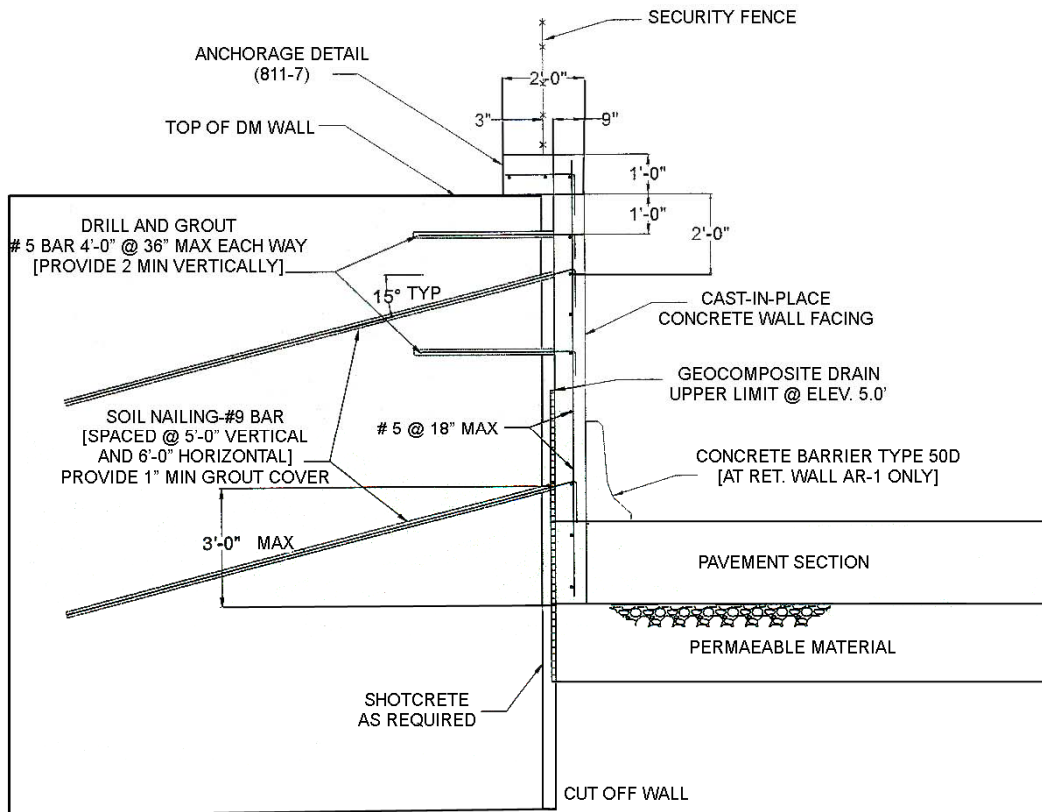

Figure 4 – 7. Design of Gravity Wall (After Yang, 2003)

4.6.4 Performance

The unconfined compressive strength of the cutoff wall ranged from 870 to 3865 kPa (126 to 560 psi) at 28 days with an average of 2064 kPa (299 psi). The permeability testing results ranged from 5.3×10^{-7} to 5.9×10^{-9} cm/s with an average of 1.9×10^{-7} cm/sec.

4.7 CASE HISTORY 6 – VERT WALL, TEXAS A&M UNIVERSITY

The VERT wall is a new type of top-down gravity retaining structures deriving its name from the vertical reinforcement used to stabilize the structure (Figure 4 – 8). Three to four rows of 1-m-diameter soil cement columns are installed in the in situ soil to the depth of the excavation. To study the behavior of the retaining wall system, Geo-Con built and instrumented a full-scale VERT wall at the National Geotechnical Experimentation site (NGES) at Texas A&M University (TAMU) (Briaud et al., 2000).



Figure 4 – 8. Completed VERT Wall (After Briaud et al., 2000)

4.7.1 Site Conditions

The site of the VERT wall consists of sand deposits. The sand, a floodplain deposit of Plesitocene age, has a high fine content with occasional clay layers due to the relatively low energy depositional environment. The bedrock is approximately 10 m (32.8 ft) below the ground surface consisting of dark gray clay shale deposited in a series of marine transgressions and regressions. The water table is 7.2 m (23.6 ft) below the ground surface.

4.7.2 Design

The design strength for the soil cement was 690 kPa (100 psi) at 28 days before starting the excavation. No specific design guidelines exist for this wall type. There is a need for such guidelines to be developed. The construction of this research wall indicated the importance of two design features: 1) it is important to have a DM platform at the top of the wall to connect all the columns together, and 2) it is important to reinforce the front row of column to resist bending beyond the tensile strength of the cement soil mixture.

4.7.3 Construction

Prior to construction, a 1-m-thick fill was placed on top of the original ground surface to ensure that the final excavation level would remain above the water table. The fill consisted of compacted sand from the site. Soil cement columns were installed using a drilling rig equipped with a 0.91-m-diameter cutting and mixing head. The drilling fluid consisted of a water and cement ratio of 1.75 to 1 while the cement slurry to soil ratio by weight was 0.55. The soil cement columns were installed to a depth of 8.5 m (27.9 ft) below the top of the fill. A front row (Row A) of 43 contiguous columns was constructed. Immediately behind this row was a second row (Row B) with center-to-center spacing of 1.82 m (5.9 ft). A third row (Row C) and a fourth row (Row D) were constructed to maintain the 1.82 m (5.9 ft) spacing. On top of the part of the wall, a 1 m thick relieving platform was built using the soil slurry spoils ejected from each hole. The global volume of soil cement installed was 9.5 m (31.2 ft) high, 5.6 m (18.4 ft) wide and 40 m (131.2 ft) long.

4.7.4 Performance

Compressive strength tests were performed on soil cement samples from various depths at 3, 7, 28 and 56 day increments. The lowest value of the unconfined strength at 28 days before construction was twice the design value. Core samples were also taken and tested. The best coring process of the soil cement column was achieved when using a triple-tub core barrel and coring 28 days or more after column construction. Compression testing at 28-days of a representative samples showed an unconfined compression strength of 2,069 kN/m² (300 psi).

The relieving platform had a very beneficial effect because it decreased the maximum deflection of the wall by a factor of 2. One and a half years after construction, the horizontal deflection at the top of the 10 m (32.8 ft) high wall was 0.025 m (0.98 in) and the vertical settlement of the same point was 0.0093 m (Figure 4 – 9).

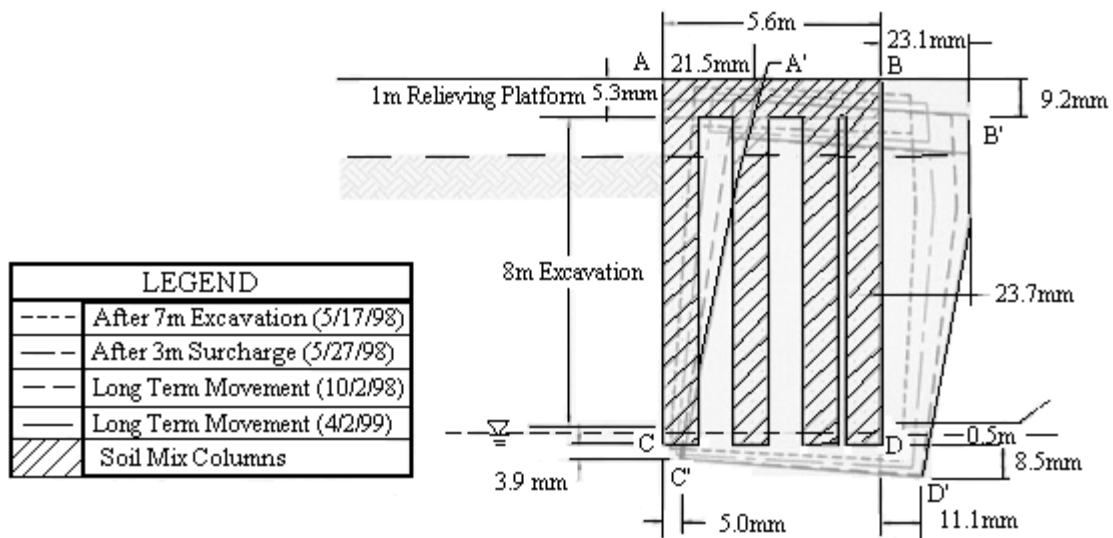

[SCALE] Displacement: Wall Size = 1:1000

Figure 4 – 9. VERT Wall Displacements (After Briaud et al., 2000)

CHAPTER 5

MODES OF FAILURE

5.1 INTRODUCTION

A variety of possible modes of failure exist for both supported walls and tieback walls. Although DM wall components differ from traditional wall elements in construction techniques and materials, they essentially perform the same function. For this reason the discussion of modes of failures for DM walls follows closely the list of mechanisms established in the literature for traditional construction. In general, failure modes can be divided into four main categories: (1) instability due to seepage; (2) global instability; (3) geotechnical failure; and (4) structural failure. The characteristics of each mode of failure for retaining systems are discussed in this chapter. Analysis methods and calculations are addressed in the design methodologies outlined in Chapter 6.

5.2 INSTABILITY DUE TO SEEPAGE

Base instability of the excavation can occur due to boiling/piping or base heave. As illustrated in Figure 5 – 1, boiling or piping occurs when the water level is lower inside the excavation than outside the excavation causing water to flow under the wall into the excavation (McNab, 2002). The effective stress in the volume of soil below the bottom of the excavation, extending to the embedment depth of the wall – referred to as plug – can be reduced significantly by the pore water pressures. As a result there can be a loss of horizontal passive resistance leading to inward failure of the retaining wall. The seepage forces may reach levels comparable to the effective stresses, causing a “quick” condition.

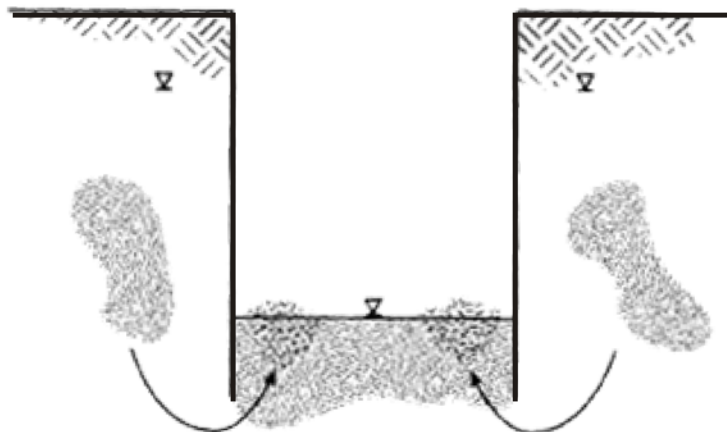

Figure 5 – 1. Boiling/Piping (After McNab, 2002)

A “cork” effect or “plug” heave occurs when the excavation site consists of sand underlying a clay layer (Figure 5 – 2).

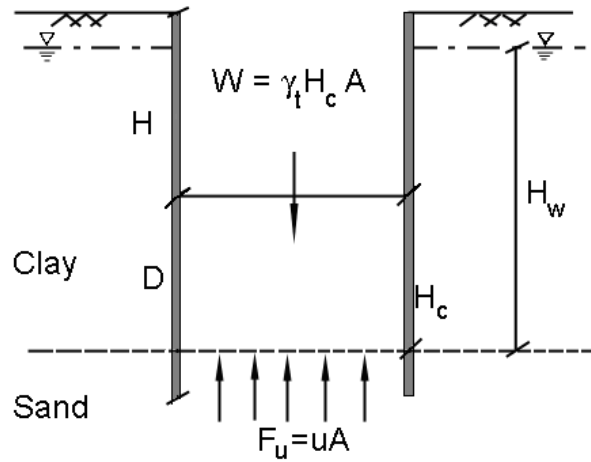

Figure 5 – 2. Plug Heave

5.3 GLOBAL INSTABILITY

5.3.1 Instability due to Global Rotation

Global instability occurs when a failure surface develops. Global stability of excavations can be analyzed using a variety of slope stability approaches. Figure 5 – 3(a) illustrates a cantilever wall global failure developing when the entire soil mass including the wall rotates along a slip surface. Global failure can cause failure of anchored walls and internally braced walls as shown in Figure 5 – 3(b–e).

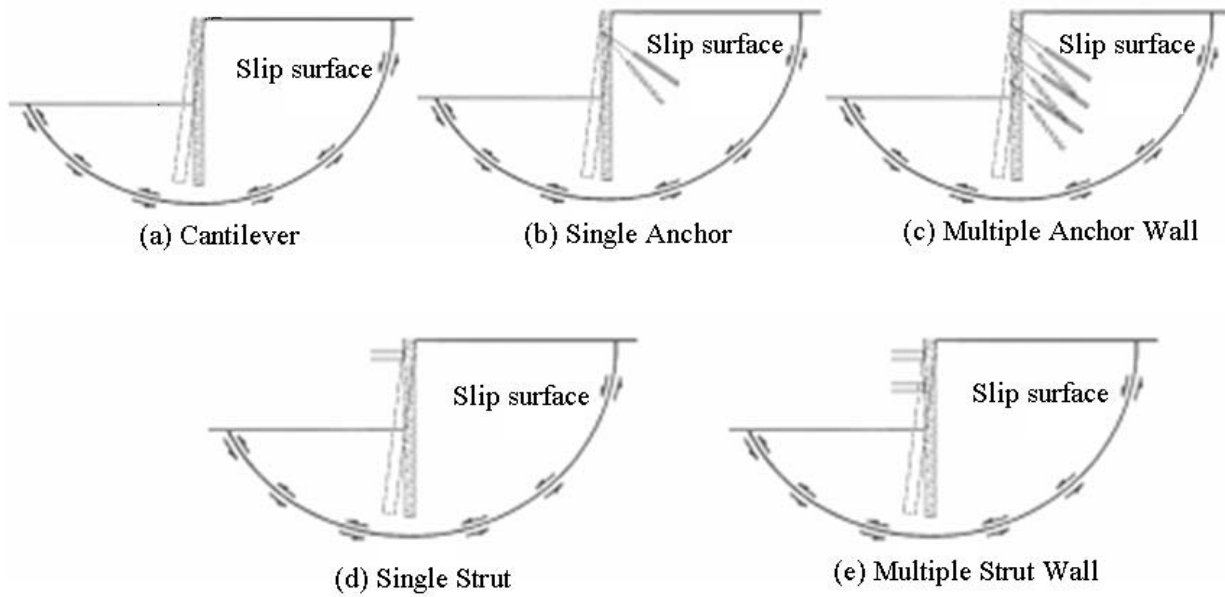

Figure 5 – 3. Global Instability wall (a) cantilever, (b) single anchor (c) multiple anchor wall (d) single strut (e) multiple strut wall

5.3.2 Instability due to Inverted Bearing Capacity

An inverted bearing capacity failure (Figure 5 – 4) occurs when the overburden pressure outside the excavation overcomes the shear strength of the soil, causing soil to flow into the excavation under the wall (McNab, 2002). Inverted bearing capacity failures not only cause instability to the excavation due to the decrease in bearing capacity, but can cause lateral movement and damage to adjacent facilities.

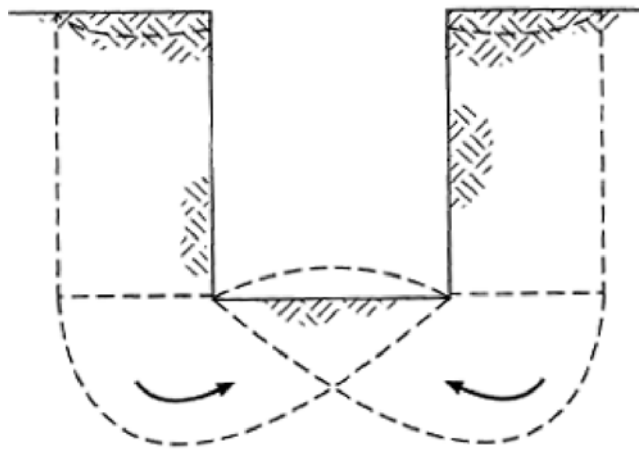

Figure 5 – 4. Inverted Bearing Capacity (After McNab, 2002)

5.4 GEOTECHNICAL FAILURE

Geotechnical failures occur when the imposed loads are greater than the strength of the soil (McNab, 2002). Figure 5 – 5(a) illustrates a case of the settlement of the soil cement columns. Settlement of the toe can occur if the downward component of the anchor and down drag on the column is larger than the bearing capacity of the soil. As the column settles the anchor rotates. This movement can cause lateral deformations and damage to adjacent facilities. Figure 5 – 5(b) illustrates passive resistance failure at the base of the excavation allowing the wall to rotate. Other geotechnical failures include failure by overturning, sliding or translation, and rotational failure of the ground mass. Raker failures are illustrated in Figure 5 – 5(c) and Figure 5 – 5(d). Column toe uplift can cause a failure in tension allowing the wall to rotate up and forward. A bearing capacity failure under the raker would cause large lateral deformations of the wall.

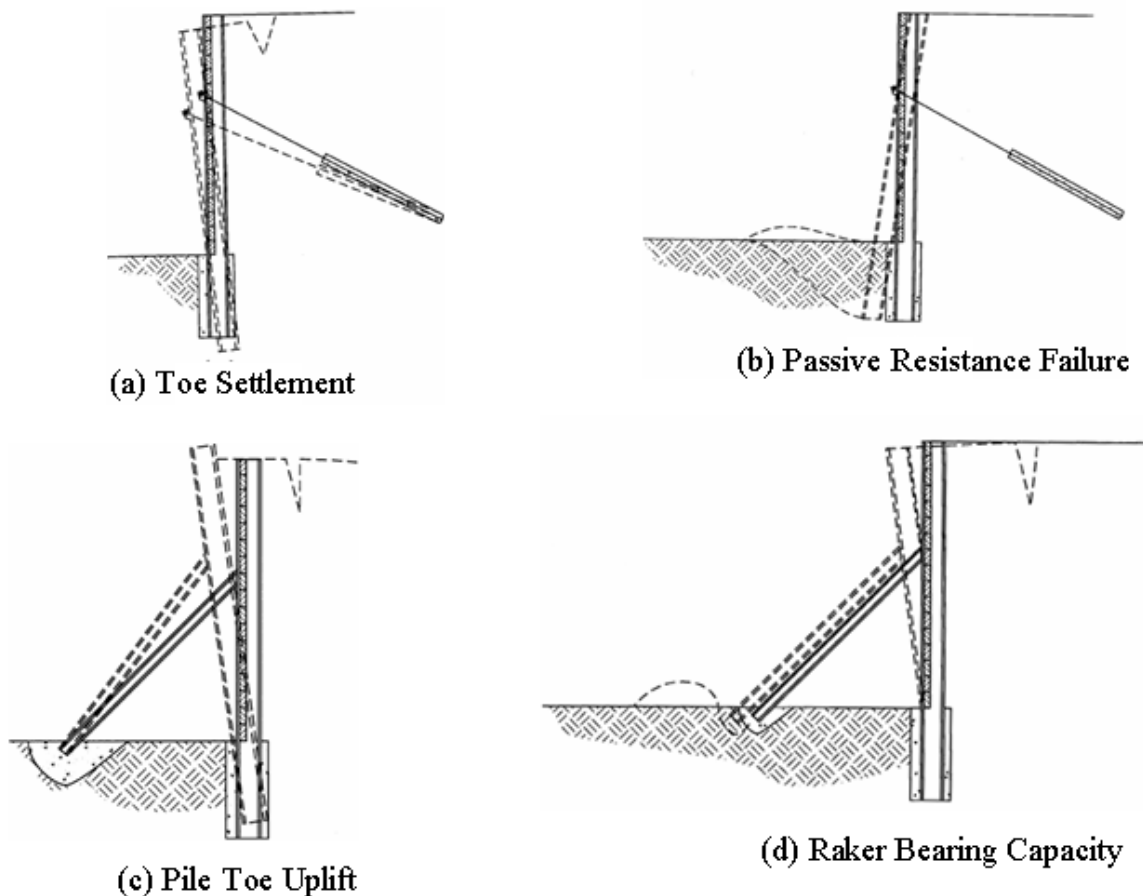

Figure 5 – 5. Geotechnical Failures (After McNab, 2002)

5.5 STRUCTURAL FAILURE

Structural failure occurs when a portion of the shoring system cannot withstand imposed loads (McNab, 2002). Examples of structural failure, shown in Figure 5 – 6(a–c), include failure of the wall above a tieback, failure of the wall at mid-span, failure of a tieback tendon or connection failures. As in the case as base instability, structural failures result in large displacements which can cause damage to nearby facilities.

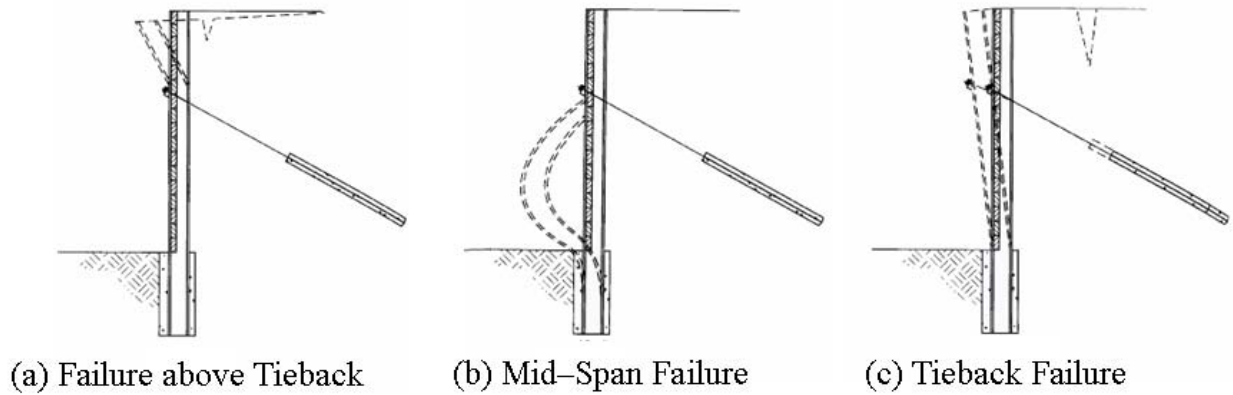

Figure 5 – 6. Structural Failure (After McNab, 2002)

CHAPTER 6

CANTILEVER AND SUPPORTED RETAINING WALL DESIGN

6.1 INTRODUCTION

Deep mixing walls are designed following techniques similar to those used for traditional excavation support methods. Three major approaches to design and analyze excavation support walls exist: (a) the hand calculation approach; (b) the beam–column approach; and (c) the finite element approach. This design manual will outline hand and chart methods and make recommendations for computer aided approaches. Although hand methods are quick, simplified calculations, computer aided analysis may be required for complex soil and site conditions. Computer aided analysis is growing in use and represents the future trend. Table 6 – 1 compares the advantages and disadvantages for each design method. Computer aided analysis is discussed in more detail in section 6.9.

Table 6 – 1. Comparison of Design Methods

Method	Data Required	Advantages	Disadvantages
Hand	$c, \phi, S_u, k,$ EI, f_{max}	Simple Quick No computer necessary	Simple soil profiles Many assumptions required Limited precision
Beam– column	c, ϕ, S_u, k $y_a, y_p, EI,$ k_{anchor}, f_{max}	Better bending moment and reaction predictions Multilayer soils Relatively Simple Models wall embedment	No seepage solution Limited precision on movement Requires computer and program
Finite Element	$c, \phi, S_u, k,$ $E_{soil}, EI,$ f_{max}, k_{anchor}	Simulates construction sequence Good bending moment predictions Good movement predictions Any geometry Multilayer Any loading Simulate construction sequence	Difficult and time consuming to use properly Requires computer and program Requires calibration Hand check desirable

6.2 SITE INVESTIGATION

The purpose of a site investigation is to obtain information used to select the type and depth of the wall, estimate earth pressures, locate the ground water level, estimate settlements, and

identify possible construction problems. For cutoff walls, seepage conditions must also be assessed. The following properties or test results should be included:

- 1) Boring logs with penetration resistances either cone penetration test (CPT) or standard penetration test (SPT), visual classifications, groundwater levels, and drillers observations. The depth should be deep enough to cover the zone of soil involved in the response to the excavation. One and a half to two times the excavation depth is often used.
- 2) Classification of the soil
- 3) Plastic and liquid limits
- 4) Unconfined compressive strength on undisturbed samples.
- 5) Grain size distribution curves for fine grained sands and silts.
- 6) Cohesion, c , and angle of internal friction, ϕ
- 7) Information on deformation properties (modulus), if possible
- 8) Location of obstructions, utilities, and adjacent facilities
- 9) Unusual occurrences

Typical site investigation parameters include effective stress cohesion intercept of the soil (c), effective stress internal friction angle (ϕ), undrained shear strength for fine grained soils (S_u), modulus of deformation of soil (E), profile of pore pressures (u), profile of initial vertical effective stress (σ'_{ov}), surcharge (q), unit weight of soil (γ), permeability (k), and level of the groundwater table (GWT).

6.3 GENERAL DESIGN PROCEDURES

After evaluating site conditions and wall performance criteria, the designer should determine if deep mixing is a viable option for the project based on the feasibility discussion in Chapter 2. Currently, soil cement excavation walls are treated similarly to soldier pile and lagging walls or secant walls. The design methodology includes steps to determine the reinforcement members to resist bending moment and shear stresses. The soil cement between the reinforcement members is considered the same way as lagging in traditional walls; with the function of resisting and redistributing the horizontal stresses to the adjacent reinforcement (Taki and Yang, 1991). The initial wall geometry is assumed. Typical wall parameters required for design analysis include height of wall (H), height of water from bottom of excavation (H_w), half the width of the excavation (w), and embedment depth (D). Figure 6 – 1 illustrates wall parameters for cantilever, single support/tieback and multiple supports/tiebacks walls.

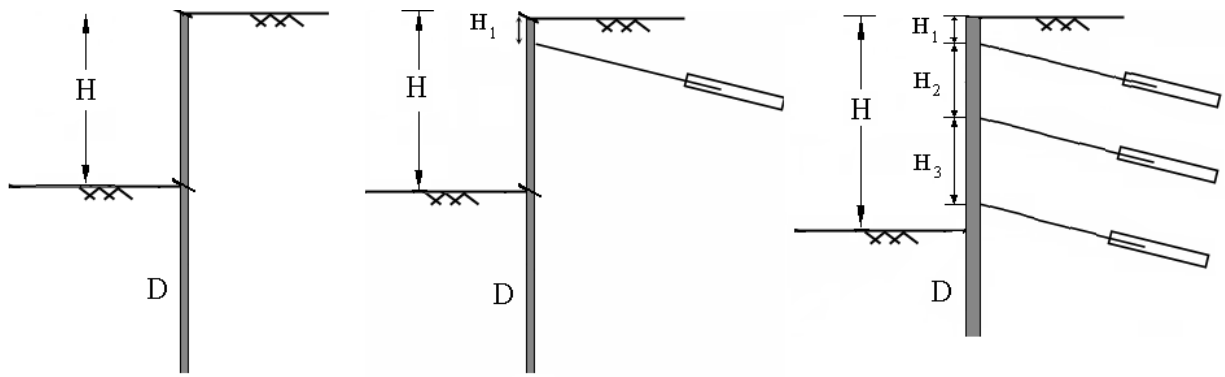

Figure 6 – 1. Cantilever, Single Support and Multiple Support Walls

In the design process, a repeatable section of wall must be identified. This is the smallest length of the wall which repeats itself over and over again to form a complete wall. For a cantilever wall, it is taken as a unit length or the diameter of a column. If an H beam is placed in the DM column every so often for reinforcement, the repeatable section is taken as the length of the wall between the midpoints on either side of an H beam including the beam (Figure 6 – 2.a). For an anchored wall, the repeatable section is the length of the wall between the midpoints on either side of an anchor or stack of anchors (Figure 6 – 2.b).

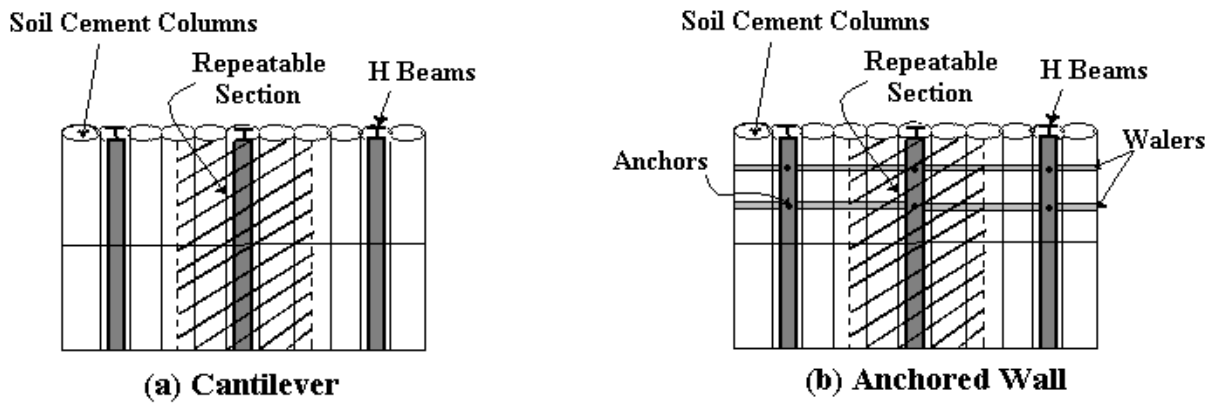

Figure 6 – 2. Repeatable Section

The general steps to design a deep mixing excavation support system are underlined in Figure 6 – 3. Once the feasibility of DM technology is determined, the function and design criteria for the wall must be established. Following this step, the soil properties are collected and design soil parameters are selected. The type of retaining wall system is decided based on cost, site conditions, required wall height, speed of construction, and other project specific requirements. A seepage analysis is carried out using initial wall geometry. The external stability is evaluated, followed by the retaining wall design. The vertical capacity of the wall is calculated and the structural resistance of the retaining elements checked. Finally, other considerations such as settlement, freeze–thaw, and seismic conditions are analyzed.

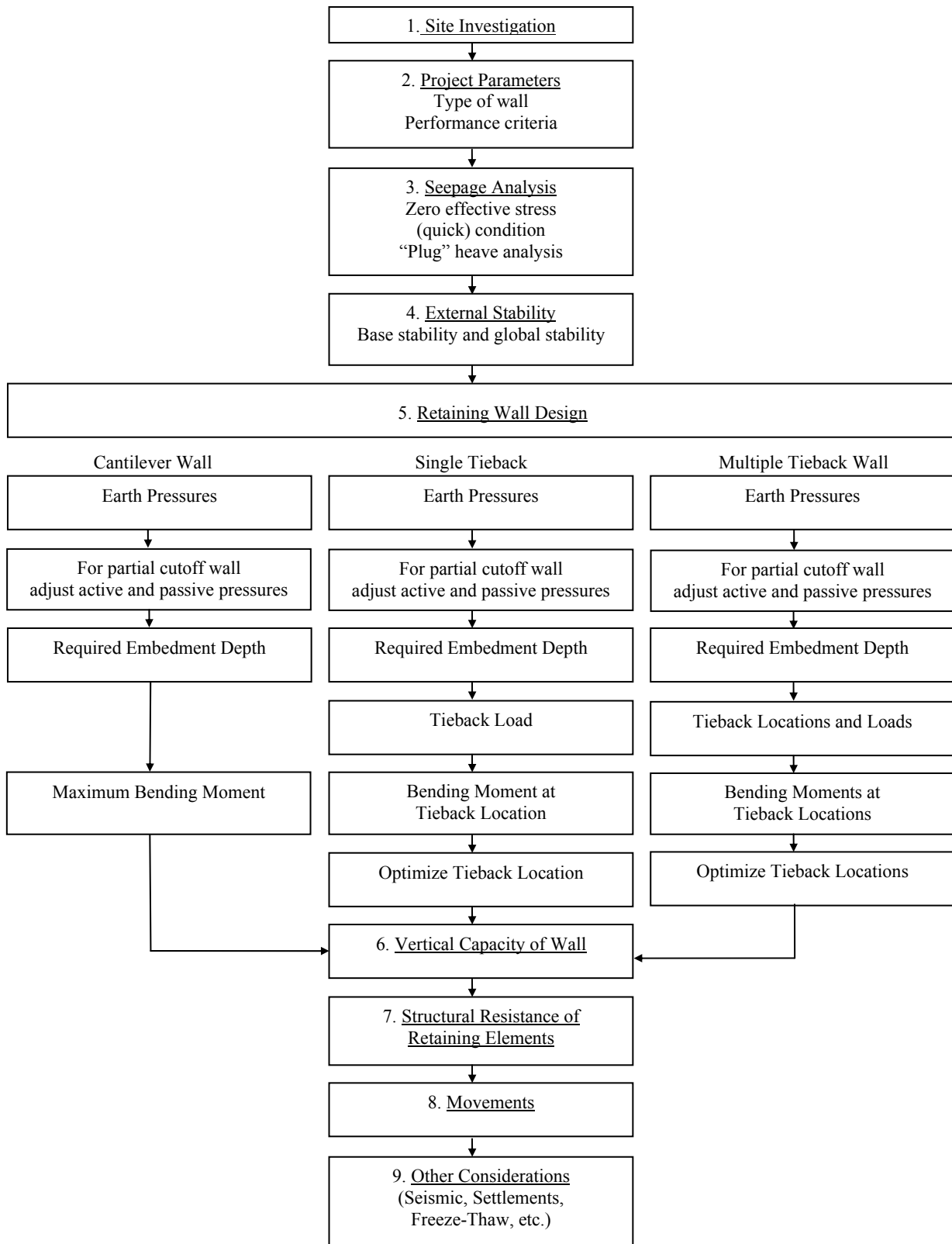

Figure 6 – 3. Deep Mixing Excavation Support Wall Design Flowchart

6.4 SEEPAGE ANALYSIS

6.4.1 Hand Methods

For temporary retaining systems, the wall should be designed to resist water forces associated with seepage behind and beneath the wall. A typical flownet for a retaining wall in homogenous soil is shown in Figure 6 – 4. Procedures to calculate effective horizontal earth pressure including effects of seepage are provided in NAVFAC DM 7.1 (1982) and FWHA–HI–97–021 (1997).

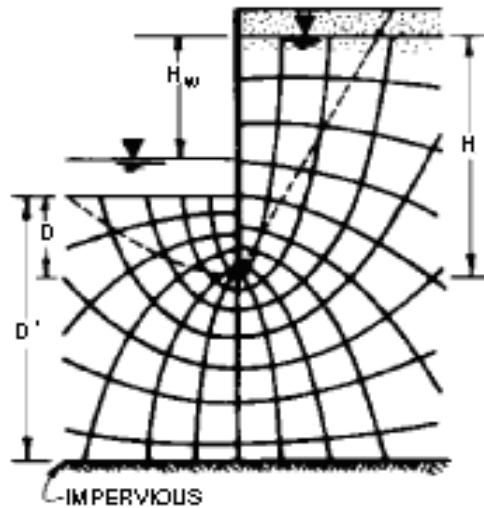

Figure 6 – 4. Typical Flownet for a Retaining Wall (After NAVFAC DM 7.1, 1982)

Piping occurs when the water head is sufficient to produce critical velocities in cohesionless soils causing a “quick” condition at the bottom of the excavation. A chart method for preventing piping in isotropic sand and stratified sand as described by NAVFAC is shown in Appendix A, Figures A – 1 and A – 2 (NAVFAC DM–7, 1982). “Quick” condition in coarse grain soils occurs when the effective stress becomes zero. Methods to decrease instability are dewatering, application of a surcharge on the bottom of excavation, or extend embedment of wall (AIR FORCE AFM 88–3, 1988).

Bottom heave should be evaluated for clay soils under seepage conditions. Bottom heave can also occur in cohesionless soils, although rare. Vertical ground displacements at the base of the excavation can lead to lateral displacements behind the wall. Bottom heave can be calculated following methods shown in Appendix A, Figure A – 3 (NAVFAC DM 7.1, 1982). The impermeable layer should be depressurized if heave is expected. The wall embedment should also be extended if heave failure is possible. Soil improvement of the base of the excavation such as buttressing is also possible to strengthen the base against heave.

A “cork” effect or “plug” heave occurs when the excavation site consists of sand underlying a clay layer (Figure 6 – 5). Failure (heave) occurs when (neglecting friction between wall and plug)

$$u = \gamma_t H_c \text{ or } H_c = \frac{u}{\gamma_t} \quad (6-1)$$

where:

u is the pore pressure at the bottom of the clay

γ_t is the total unit weight of the soil

H_c is the height of the clay layer

Ensure that:

$$H_{c(\text{design})} = F H_{c(\text{failure})} \quad (6-2)$$

where:

F is the chosen factor of safety

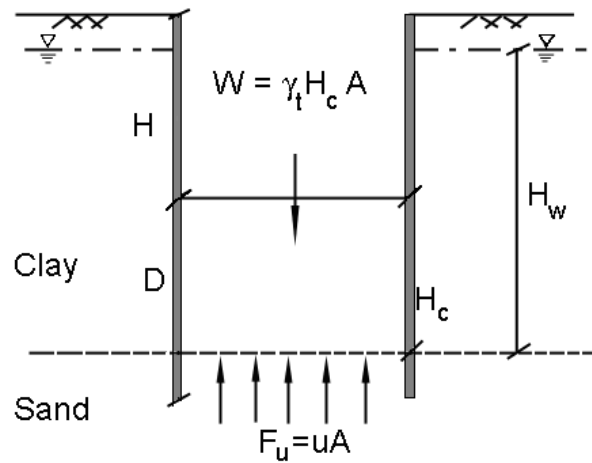

Figure 6 – 5. Plug Heave When the Site Consists of Clay over Sand

6.4.2 Computer Aided Analysis

A variety of finite element software exist that can be used to model seepage and pore–water pressure distributions. Some programs allow both saturated and unsaturated flow modeling and the ability to model the dissipation of excess pore–water pressure. Common required inputs include geometry, material properties (coefficient of hydraulic conductivity, unit weight), and boundary conditions. Program output includes velocity vectors, flow paths, flux values, phreatic surface lines and flownets. Example programs include SEEP–W, GEOWFLOW, FLONET and PLAXIS.

6.5 EXTERNAL STABILITY

6.5.1 Hand Methods

An overall or global stability analysis looks at rotational or compound failure mechanisms. A classical slope stability analysis is used to determine the external stability of the retaining system. Classical methods include method of slices, Bishop's method, Janbu's method, wedge method, and others. Typical potential failure surfaces include circular failure surface, noncircular failure surface and sliding block failure surface. Figure 6 – 6 illustrates a circular slip failure analysis for a global stability analysis.

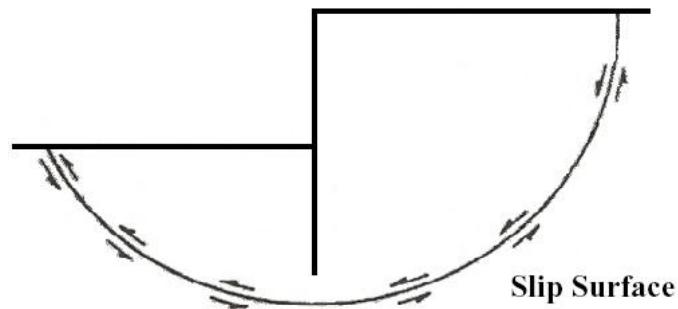

Figure 6 – 6. Circular Slip Failure

Base stability analysis consists of an inverted bearing capacity failure analysis (Figure 6 – 7). An inverted bearing capacity failure occurs when the difference in overburden pressures between the outside and the inside of the excavation overcomes the shear strength of the soil, causing the soil to flow into the excavation under the wall (McNab, 2002). NAVFAC DM 7 provides procedures shown in Figure A – 4 of Appendix A.

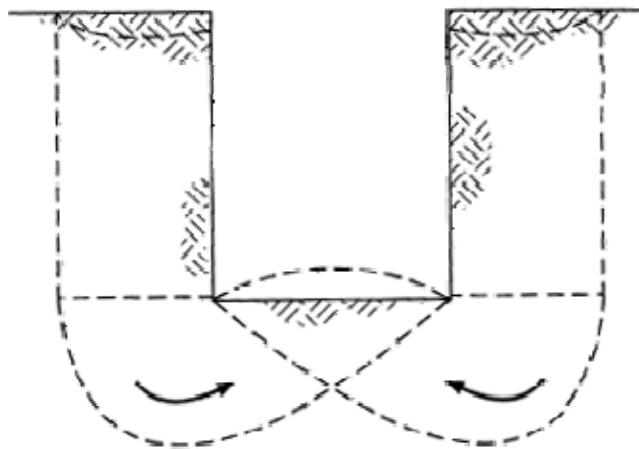

Figure 6 – 7. Inverted Bearing Capacity (After McNab, 2002)

6.5.2 Computer Aided Analysis

Global stability analysis can be performed using programs such as G-Slope, STABLE, GEOSLOPE, and XSLOPE that evaluate potential slip surfaces or failure planes and perform Bishop and Janbu methods of analysis. Typical input includes geometry, soil properties (shear strength parameters, unit weight), loading and surcharge conditions and water conditions. Output includes factors of safety and potential failure surfaces.

6.6 CANTILEVER WALL DESIGN

A cantilever retaining walls derives its support from the passive resistance developed in the soil below the excavation level in front of the wall (Figure 6 – 8). The wall must penetrate to a sufficient embedment. For preliminary design use an embedment depth equal to 1.3 times the height of excavation (Briaud et al., 1983).

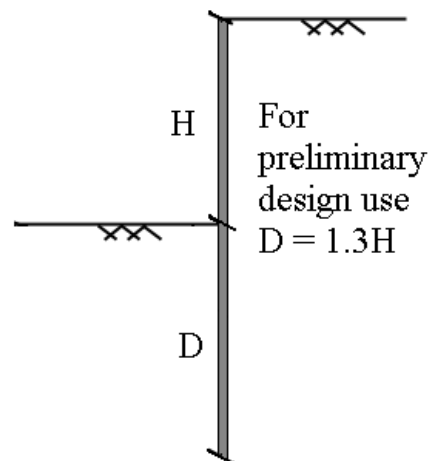

Figure 6 – 8. Cantilever Wall

6.6.1 Earth Pressures: Active, Passive

The Rankine earth pressure model has been found to reasonably predict wall forces for cantilever wall design (McNab, 2002). The active and passive pressure diagrams are triangular. An undrained analysis should be used in addition to the effective stress analysis when the soil type is appropriate.

The active pressure is the minimum horizontal earth pressure value possible at any depth due to movement or rotation of the wall away from the soil. This wall movement allows horizontal expansion of the soil toward the wall. The active total horizontal pressure, σ_{ah} , at a depth z below the top of the wall for an **effective stress analysis** is calculated using Equation 6 – 3. (Active pressure assumed to be zero if negative). The coefficient of active earth pressure, K_a , is calculated using Equation 6 – 4 for a vertical wall, horizontal backfill, with no friction between

soil and wall. For the general case use Figure A – 5 and Table A – 1 for wall friction in Appendix A (NAVFAC DM 7.2, 1982).

$$\sigma_{ah} = K_a (\sigma'_{ov} + \Delta\sigma'_v) - 2c\sqrt{K_a} + \alpha u \quad (6-3)$$

where:

σ_{ah} is the total active earth pressure

K_a is the active earth pressure coefficient (Eq. 6 – 4)

c is the effective stress cohesion intercept of the soil at depth z

σ'_{ov} is the initial vertical effective stress at depth z

$\Delta\sigma'_v$ is the change in vertical effective stress at depth z (due to load at the surface of the retained side)

α is the ratio of water over total pore area (use 0 for unsaturated soils or soils in the capillary zone, and 1 for saturated soils under the GWT)

u is the water stress (pore water pressure if saturated)

$$K_a = \tan^2\left(45^\circ - \frac{\phi}{2}\right) \quad (6-4)$$

where:

K_a is the active earth pressure coefficient

ϕ is the internal friction angle

The passive pressure is the maximum horizontal pressure due to movement or rotation of the wall toward the soil. The passive total horizontal pressure, σ_{ph} , at a depth z below the top of the wall for an **effective stress analysis** is calculated using Equation 6 – 5. The coefficient of passive earth pressure, K_p , is calculated using Equation 6 – 6 for a vertical wall, horizontal backfill, no friction between soil and wall.

$$\sigma_{ph} = K_p (\sigma'_{ov} + \Delta\sigma'_v) + 2c\sqrt{K_p} + \alpha u \quad (6-5)$$

where:

σ_{ph} is the total passive earth pressure

K_p is the passive earth pressure coefficient (Eq. 6 – 6)

c is the effective stress cohesion intercept of the soil at depth z

σ'_{ov} is the initial vertical effective stress at depth z

$\Delta\sigma'_v$ is the change in vertical effective stress at depth z (due to load at the surface of the retained side)

α is the ratio of water over total pore area (use 0 for unsaturated soils or soils in the capillary zone, and 1 for saturated soils under the GWT)

u is the water stress (pore water pressure if saturated)

$$K_p = \tan^2\left(45^\circ + \frac{\phi}{2}\right) \quad (6-6)$$

where:

K_p is the passive earth pressure coefficient

ϕ is the internal friction angle

For the general case use Figure A – 6 and Table A – 1 for wall friction in Appendix A. Figure 6 – 9 illustrates the earth pressures for an effective stress analysis.

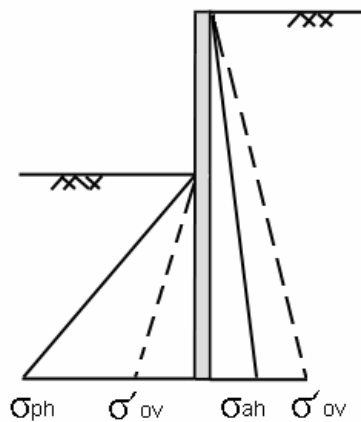

Figure 6 – 9. Earth Pressures for Effective Stress Analysis

The active and passive earth pressures for an **undrained total stress analysis** are calculated using Equations 6 – 7 and 6 – 8, respectively.

$$\sigma_{ah} = \sigma_{ov} + \Delta\sigma_v - 2S_u \quad (6 - 7)$$

where:

σ_{ah} is the total active earth pressure

σ_{ov} is the total initial vertical stress at depth z

$\Delta\sigma_v$ is the change in total vertical stress at depth z (due to load at the surface of the retained side)

S_u is the undrained shear strength of the soil at depth z

$$\sigma_{ph} = \sigma_{ov} + \Delta\sigma_v + 2S_u \quad (6 - 8)$$

where:

σ_{ph} is the total passive earth pressure

σ_{ov} is the total initial vertical stress at depth z

$\Delta\sigma_v$ is the change in total vertical stress at depth z (due to load at the surface of the retained side)

S_u is the undrained shear strength of the soil at depth z

If a partial cutoff wall is used and water flows into the excavation, then the active and passive earth pressures must be adjusted. Indeed the dynamic pore pressure obtained from the steady state flow net is different from hydrostatic and therefore impacts u and σ'_{ov} in Equation 6 – 3 and 6 – 5. Figure A – 7 in Appendix A presents procedures to determine the reduction in water pressure and increase in earth pressure behind the wall (active pressure side) as well as the increase in water pressure and reduction of the earth pressure in front of the wall (passive pressure side). Figure 6 – 10 illustrates the earth pressures for an undrained total stress analysis.

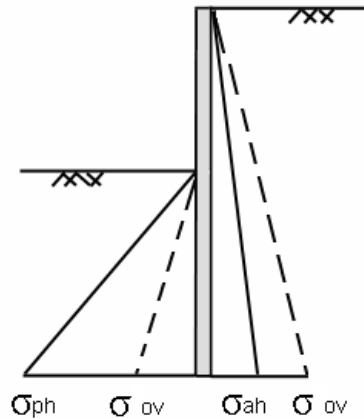

Figure 6 – 10. Earth Pressures for Undrained Total Stress Analysis

6.6.2 Required Embedment Depth, D

A first estimate for the depth of the embedment is $1.3H$ where H is the height from the surface to the bottom of the excavation. Draw the active pressure diagram (Figure 6 – 11), find the resultant active force, P_a , on the wall and its location. Draw the passive diagram, find the resultant passive force, P_p , and its location. Divide P_p by an appropriate factor of safety, F . Both P_a and P_p/F are functions of D . Writing moment equilibrium around the bottom of the embedded portion gives D . A force, R , exists near the bottom of the wall in the same direction as P_a . This force often called the kick-back force is the difference between P_a and P_p/F . R is assumed to be at the bottom of the wall.

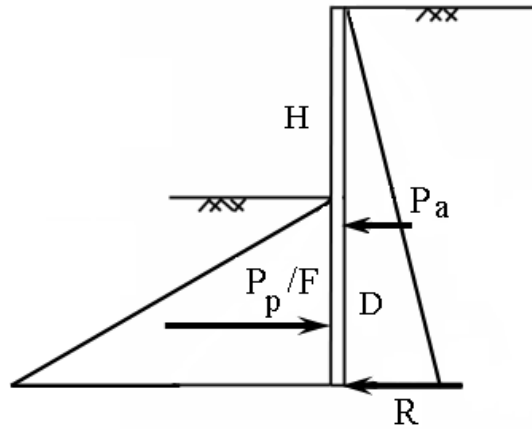

Figure 6 – 11. Earth Pressures for Excavation Support Systems

6.6.3 Maximum Bending Moment

The active pressure diagram ($\sigma_{ah}(z)$) and the factored passive pressure diagram ($\sigma_{ph}(z)/F$) are combined into one net pressure diagram. The shear and bending moment diagrams are prepared for the wall by using standard structural analysis techniques. The maximum bending moment is found at the point of zero shear. Determination by hand is difficult especially for complex stratigraphy. Therefore, this method is not recommended for determining the maximum bending moment. It is recommended to use a beam-column or a finite element program to obtain the bending moment diagram. Once the maximum moment has been determined, the appropriate structural section can be selected for the wall.

6.7 SINGLE SUPPORT/TIEBACK WALL DESIGN

Figure 6 – 12 illustrates a typical single support/anchor wall. Numerous design guidelines and specifications have been written for anchored/tiebacked walls (AASHTO, 1994; Sabatini et al., 1997; Weatherby, 1998).

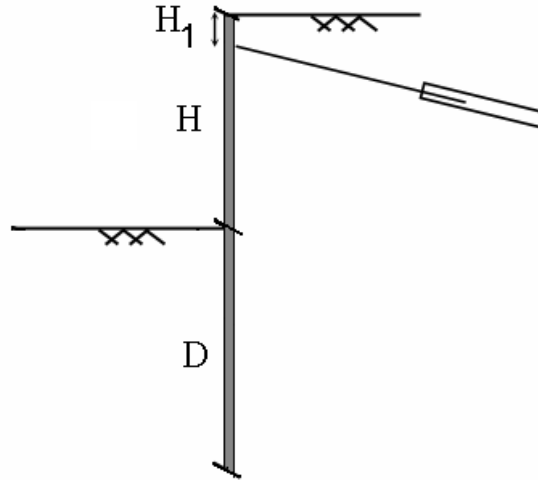

Figure 6 – 12. Single Tieback Wall

6.7.1 Earth Pressures

Earth pressure diagrams for the design of single support/tieback walls have been a topic of much debate. Some recommend that a triangular earth pressure diagram (as with cantilever walls) be used for single row anchored walls. Weatherby, (1998) and Mueeler, et al. (1998) recommend that the same apparent earth pressure diagrams used to design walls with multiple support/tiebacks be used to design single support/tieback walls.

The earth pressure for single support/tieback walls above the excavation level is determined using the apparent earth pressure theory (Terzaghi and Peck, 1967). The apparent total earth pressure envelope for sand is rectangular and determined using Equation 6 – 9.

$$\sigma_{\text{apparent}}(z) = 0.65 K_a \sigma'_{ov} + \alpha u(z) \quad (6 - 9)$$

where:

σ_{apparent} is the apparent total earth pressure

K_a is the coefficient of active earth pressure

σ'_{ov} is the effective vertical stress on the retained side at the excavation level

α is the ratio of water over total pore area (use 0 for unsaturated soils or soils in the capillary zone, and 1 for saturated soils under the GWT)

u is the water stress at depth z

The apparent total earth pressure envelope for clay is determined using Equation 6 – 10.

$$\sigma_{\text{apparent}}(z) = \beta \sigma'_{ov} + \alpha u(z) \quad (6 - 10)$$

where:

σ_{apparent} is the apparent total earth pressure

β varies between 0.2 to 0.4

σ'_{ov} is the effective vertical stress on the retained side at the excavation level

α is the ratio of water over total pore area (use 0 for unsaturated soils or soils in the capillary zone, and 1 for saturated soils under the GWT)

u is the water stress at depth z

The apparent total earth pressure or total horizontal pressure above the excavation, σ_h , can also be determined using a deformation control approach (Briaud and Lim, 1999) and is calculated using Equation 6 – 11. Deformation control design is discussed in more detail in section 6.12.

$$\sigma_h = k \sigma'_{ov} + \alpha u \quad (6 - 11)$$

where:

σ_h is the constant total horizontal pressure above the excavation

k is the coefficient of apparent earth pressure (

Figure 6 – 13 or Figure 6 – 14)

σ'_{ov} is the effective vertical stress on the retained side at the excavation level

α is the ratio of water pore cross section area over the total pore cross section area. ($\alpha = 1$ for saturated soils under the GWT and $\alpha = 0$ for unsaturated soils or soils in the capillary zone)

u is the water stress (pore water pressure)

The earth pressure coefficient, k , is determined using

Figure 6 – 13 or Figure 6 – 14 which link k and deflection. These figures were generated using multiple case histories and finite element method (FEM) simulations (Briaud and Lim, 1999). The graphs allow for the earth pressure coefficient to be determined using specified deflection criteria. The application of these recommendations is limited by the range of parameters studied.

The active and passive earth pressures below the excavation are determined following the same procedures discussed for the cantilever wall.

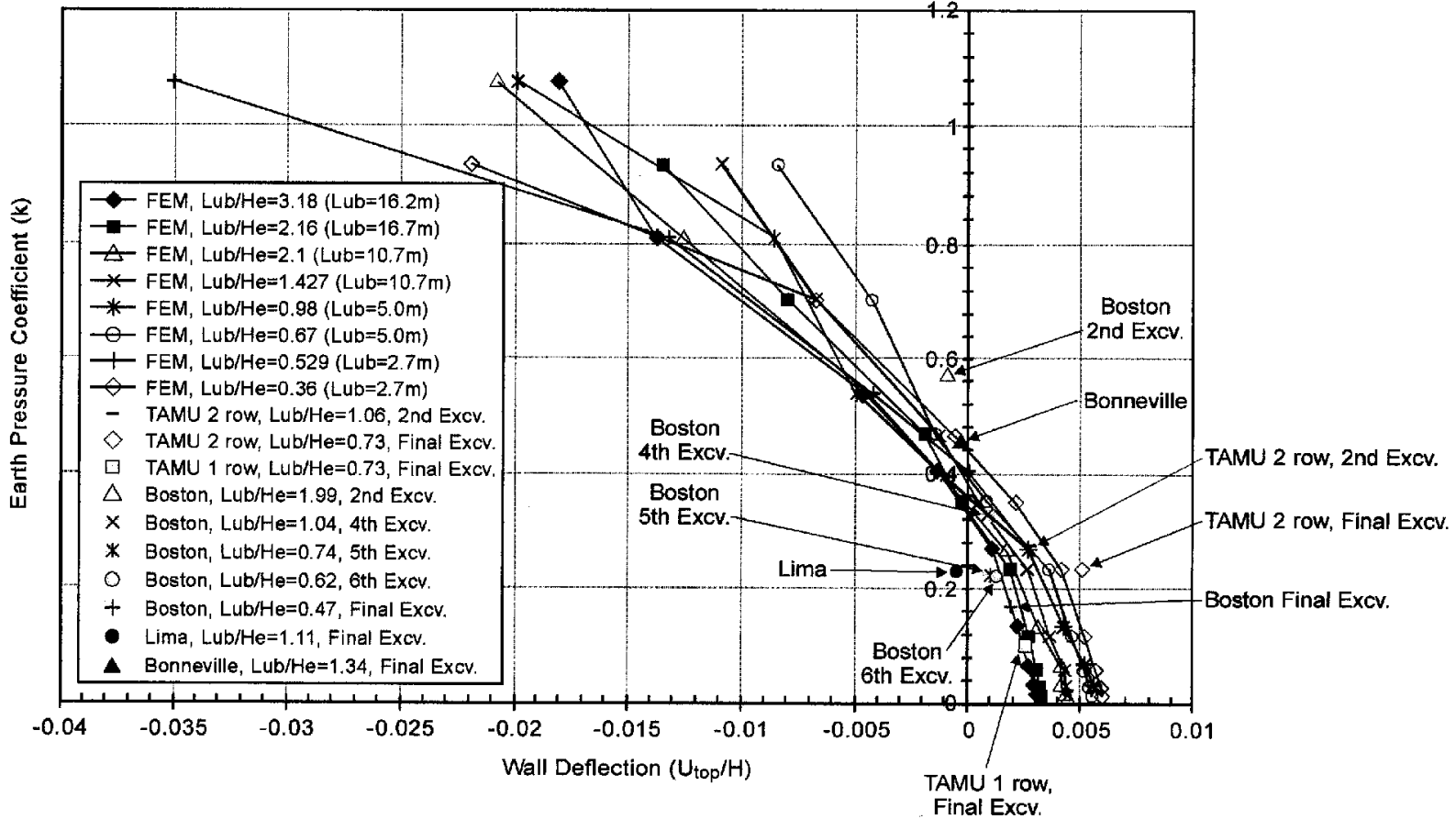

Figure 6 – 13. Earth Pressure Coefficient Versus Top Deflection
(Briaud and Lim, 1999)

(note: Earth pressure coefficient = mean pressure behind wall divided by unit weight times wall height;
Wall deflection = deflection at the top of the wall divided by the wall height)

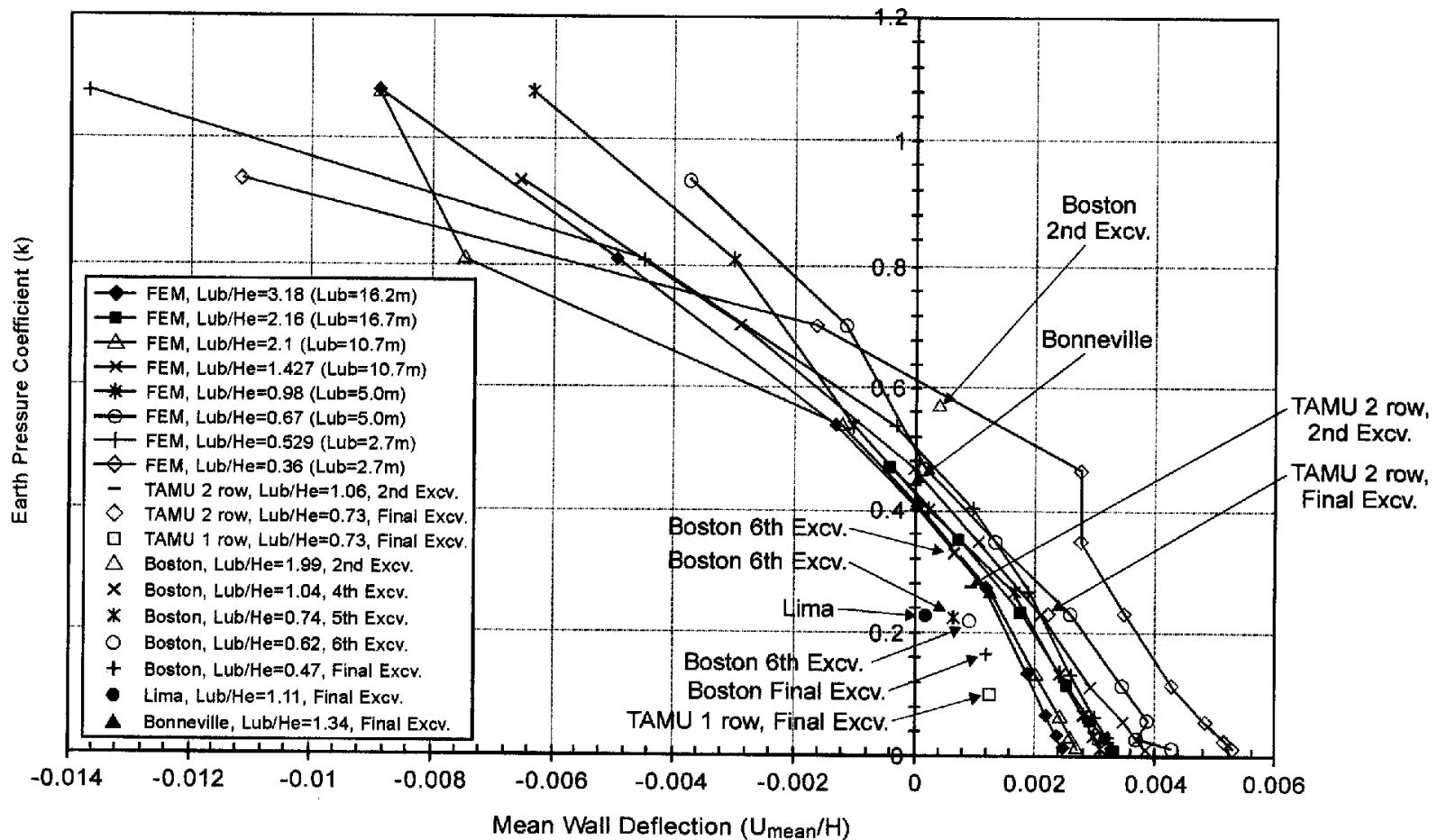

Figure 6 – 14. Earth Pressure Coefficient Versus Mean Wall Deflection
(Briaud and Lim, 1999)

(Note: Earth pressure coefficient = mean pressure behind wall divided by unit weight times wall height;
Wall deflection = mean deflection of the wall divided by the wall height)

Figure 6 – 15 illustrates the earth pressures for a single support/tieback wall.

6.7.2 Required Embedment Depth, D

There are now three unknowns: the depth of embedment, D , the anchor force, T , and the kickback force, R . The anchor load, T , is determined using the tributary area method. It consists of attributing the area of the pressure diagram covered by the tieback (hatched area in Fig 6 – 15). The resultant active force, P_a , is below the excavation depth. The resultant passive force, P_p , is located on the retaining portion of the wall. P_p is divided by an appropriate factor of safety, F . Both P_a and P_p/F are functions of D . The kickback force, R , is assumed to be located at the bottom of the wall. The embedment depth, D , can be determined by taking moment equilibrium at the bottom of the wall. Once D is known, horizontal equilibrium gives R (see Figure 6 – 15).

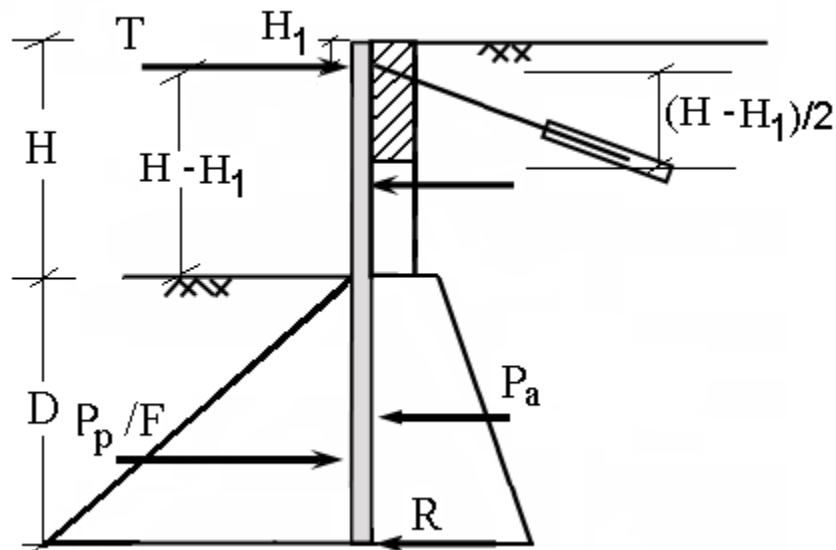

Figure 6 – 15. Apparent Earth Pressure

6.7.3 Determine Anchor Load, Anchor Length, etc.

The anchor/tieback load is determined as discussed above using the tributary area method. Anchor design elements such as anchor type, corrosion protection, length, spacing, anchor resistance, bond length, and connection to retaining systems are determined following typical anchored wall design methodologies (see Weatherby, 1998; Sabatini et al., 1999).

6.7.4 Maximum Bending Moment at Tieback Location

There are two maximum bending moments, one at the anchor point and one in the lower part of the wall. The larger of the two moments for common tieback loads and common configurations is often at the anchor point. The shear and bending moment diagrams are developed using basic

structural analysis. The maximum bending moment is found and the design of the wall's structural elements is based on this value.

6.7.5 Optimize Tieback Location

The tieback location is moved along the wall to optimize the two calculated moments. However, it is also essential to remember that placing the tieback close to the top of the wall is one of the best ways to limit deflection at the top of the wall.

6.8 MULTIPLE SUPPORTS/TIEBACKS WALL DESIGN

Multiple tieback walls are commonly used for excavation support in current practice. As discussed for the single support/tieback wall, specific design guidelines and specifications have been written for anchored/tiebacked walls (AASHTO, 1994; Sabatini et al., 1997; Weatherby, 1998). Figure 6 – 16 illustrates a multiple anchor deep mixed wall.

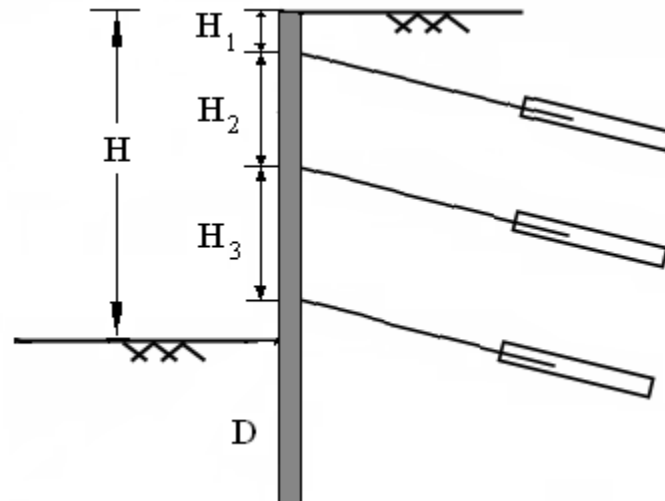

Figure 6 – 16. Multiple Tieback Wall

6.8.1 Earth Pressures: Apparent

The earth pressure diagrams for multiple supported/anchored walls are determined as described above for the single support/tieback wall. The pressure diagram above the excavation is determined using apparent earth diagrams. Below the excavation, the active pressure diagram is calculated on the retained side and the passive pressure diagram on the retaining side.

6.8.2 Determine Anchor Loads

The anchor loads are determined by the tributary area method. For example, the top tieback carries the area from the top of the wall to the midpoint between the first and second tieback.

The bottom tieback carries the area from the midpoint of the last two tiebacks to the midpoint between the bottom tieback and the excavation level (hatched area in Figure 6 – 17).

6.8.3 Required Embedment Depth, D

The embedment depth, D , can then be calculated from moment equilibrium about the base of the wall once the anchor loads are determined. The active resultant force, P_a , and its location are calculated. The passive resultant force, P_p , and its location are calculated. The force, P_p is divided by an appropriate factor of safety. The kickback force, R , is determined from horizontal equilibrium between the anchor forces, the apparent pressure diagram, P_a , and P_p/F (see Figure 6 – 17).

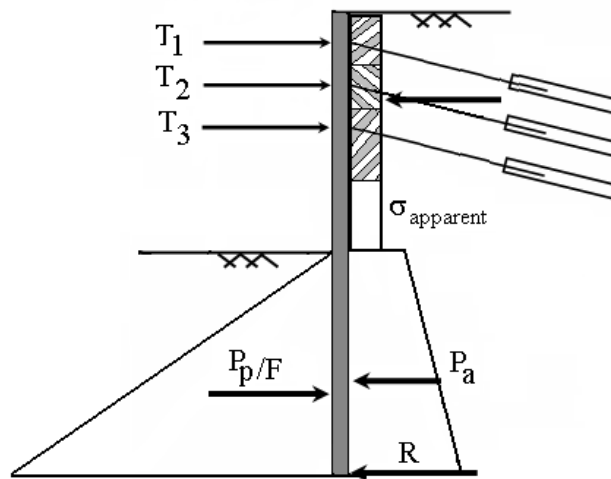

Figure 6 – 17. Apparent Earth Pressure Multiple Tieback

6.8.4 Bending Moments at Tieback Locations

It is difficult, if not undesirable, to determine bending moments by hand calculations in this complex case. The finite difference (beam–column) approach is recommended in this case. One simplification consists of assuming that the maximum bending moment occurs at the location of the top anchor and calculating the moment at the anchor due to the apparent pressure acting between the top of the wall and the first anchor. Another simplifying assumption consists of assuming the wall is broken into simple beam sections at each support and calculating the moment in the middle of each. The bending moments are also calculated prior to installation of each tieback.

6.8.5 Optimize Tieback Locations

The locations of the tiebacks are optimized to balance the moments and minimize deflections.

6.9 COMPUTER AIDED ANALYSIS

Two computer based methods, the boundary element method, BEM, and finite element method, FEM, are growing in popularity over the pressure diagram/hand calculation method. BEM is also called the beam-column method (BMCOL), finite difference method or p - y/t - z curve method.

6.9.1 Beam-Column Method

The boundary element method, BEM (Figure 6 – 18), consists of modeling the wall as a set of vertical elements Δz long with a bending stiffness, EI , and an axial stiffness, AE . The soil is represented by a series of vertical and horizontal springs placed along the wall. Spring models for tieback walls have been recommended by Briaud and Kim (1998). Typical programs include BMCOL and TBWALL. A typical input for the BEM is the length of the wall, the length of the wall elements, the wall stiffness in bending, EI , and axially, AE for the width of the repeatable section, the anchor loads or better the anchor non linear springs (horizontal and vertical), the soil non linear springs (horizontal including water loads and vertical). A typical output is the profile of the lateral and vertical deflections of the wall as a function of depth, the profile of the wall slope, the profile of the bending moment, the profile of the shear, the profile of the axial load, and the profile of the line load. Great care must be taken to represent a repeatable section of the wall horizontally.

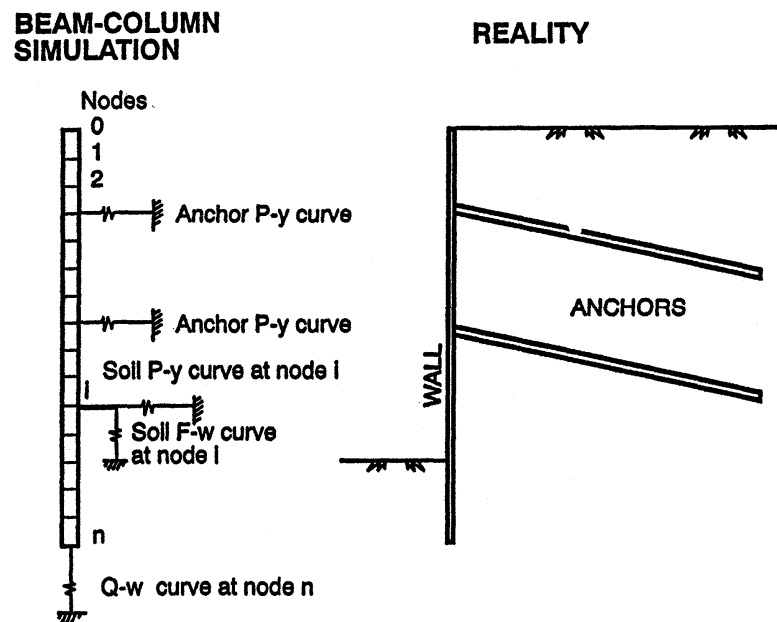

Figure 6 – 18. Boundary Element Model of Repeatable Section of Wall
(After Briaud and Kim, 1998)

The beam-column method for tieback walls deals with the analysis of the wall as a structural element interacting with the soil and the anchors; it leads to sizing the wall and the anchors (Briaud and Kim, 1998). An element of wall is considered. Horizontal equilibrium of this element together with the constitutive law for the wall in bending ($M=EI d^2y/dz^2$) and the

constitutive law for the soil [$P=P(y, z)$] leads to one of the governing differential equations (Matlock et al. 1981)

$$EI \frac{d^4 y}{dz^4} + Q \frac{d^2 y}{dz^2} - P(y, z) = 0 \quad (6 - 12)$$

where:

E = wall modulus

I = wall moment of inertia

y = wall horizontal deflection at depth z

Q = axial load in the wall at depth z

P = horizontal soil reaction for a wall deflection y at a depth z .

The soil reaction P is a load per unit height of wall (kN/m, for example).

Vertical equilibrium of the same element together with the constitutive law for the wall in compression ($Q=AE dw/dz$) and the constitutive law for the soil [$F = F(w, z)$] lead to second governing differential equation (Matlock et al. 1981)

$$AE \frac{d^2 w}{dz^2} + F(w, z) = 0 \quad (6 - 13)$$

where:

E = wall modulus

A = wall cross section

w = wall vertical deflection at a depth z

F = vertical soil reaction for a wall deflection w at a depth z .

The soil reaction F is a load per unit height of wall.

Eqs. (6 – 12) and (6 – 13) are solved by the finite difference technique after considering that the wall is made of n elements having $n + 1$ vertical deflections w_i are the unknowns in the $n + 1$ finite difference versions of (6 – 12) and $n + 1$ finite difference versions of (6 – 13) including the boundary conditions. Once the deflections y_i and w_i are known, the bending M , the shear V , the soil reaction P , and the axial-load W can be obtained through their relation to y and w .

One of the critical steps in the beam-column approach is to decide what width of wall will be simulated with a program such BMCOL76 (Matlock et al. 1981). For the slurry wall type, it is recommended that a width b equal to the horizontal spacing between anchors be used and that the width, b , centered around a vertical row of anchors. The moment of inertia I is equal to $bt^3/12$ where t is the thickness of the slurry wall. The soil reaction, P , is equal to pb , where p is the pressure behind the wall. The vertical soil reaction, F , is equal to $pb \tan \delta$, where δ is the soil-wall friction angle. For the soldier pile and lagging wall, it is recommended that a width b equal to the horizontal spacing between soldier piles be used and that the width, b , be centered around a soldier pile. The moment of inertia, I , is equal to the moment of inertia of the soldier pile; the horizontal soil reaction, P , is equal to pb , where p is the pressure behind the wall. The vertical

soil reaction, F , is equal to $pb \tan \delta$, with δ being the soil-wall friction angle (Briaud and Kim, 1998).

6.9.2 Finite Element Method

The finite element method, FEM (Figure 6 – 19), consists of modeling the wall and the soil as made of small elements and assigning to the elements properties which control their behavior. Beam elements are usually chosen to represent the wall while brick elements are used for the soil. A typical input for the FEM is the mesh description including the geometry of the elements for the wall, the anchors, the soil, the models for the wall material (usually elastic), the anchors (elastic–plastic), the soil and water (hyperbolic non linear elastic or other), boundary conditions (fixed, free, or rollers), and the boundary loads (surcharge, buildings, etc.). A typical output includes the profile of lateral and vertical deflections for the wall, the profile of vertical deflection for the ground surface, the profiles of the slope, bending moment, shear, axial load and line load for the wall. An example of such simulation is given by Briaud and Lim (1997, 1999). FEM simulations lead to bending moment predictions which are as good as BEM simulations but to wall movement predictions which are much more accurate than the BEM predictions; the reason is that mass movements are included in the FEM and not in the BEM. Typical programs include PLAXIS, FLAC and ABAQUS. Great care must be taken to place the mesh boundaries far enough from the zone to be studied and to select a soil model (modulus, strength), which describes well the soil at the site, and to select an appropriate repeatable section of wall.

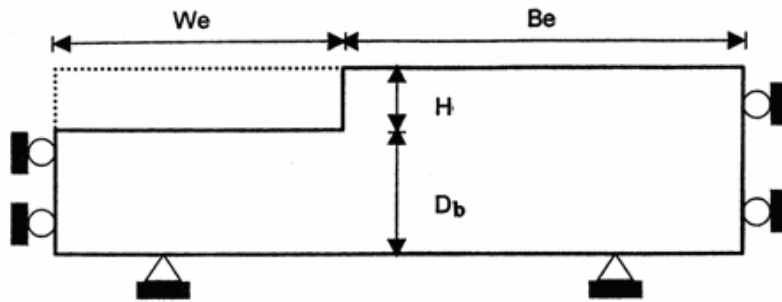

(a) Definition of H , B_e and D_b

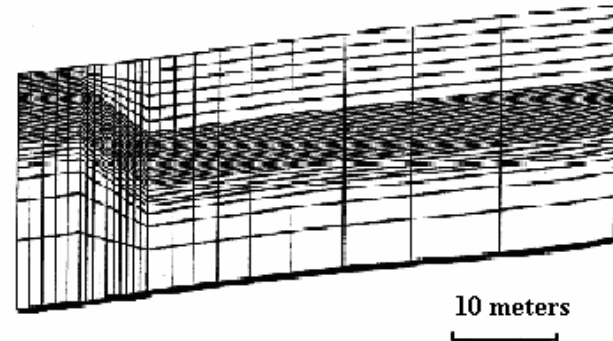

(b) Finite Element Mesh

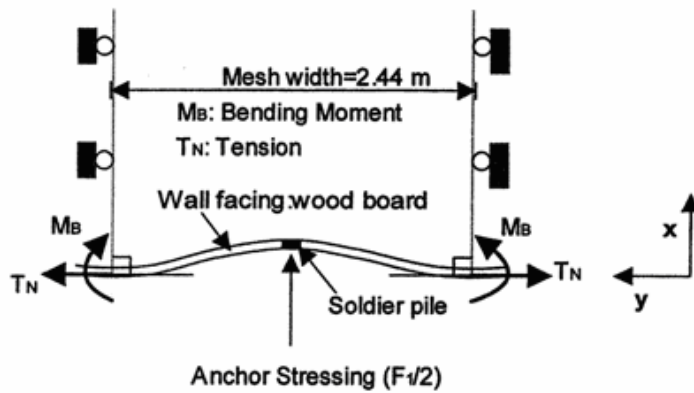

(c) Force and boundary condition requirements: Plan view

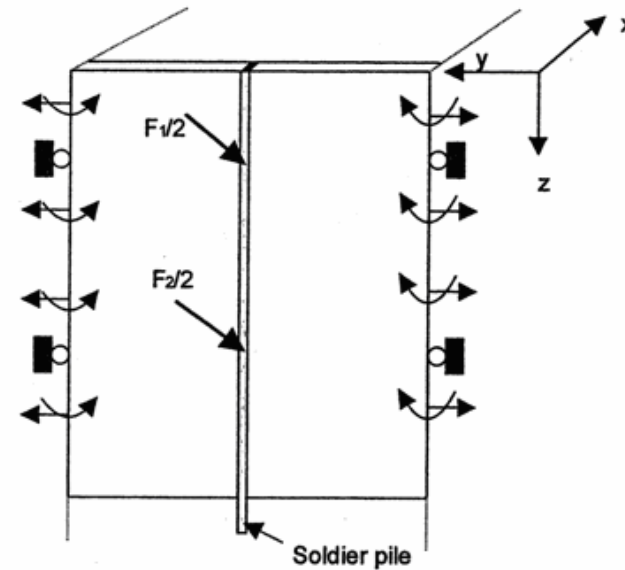

(d) Force and boundary condition requirements: Front view

Figure 6 – 19. Finite Element Method Parameters (After Briaud and Lim, 1999)

Briaud and Lim (1999) studied the boundary effect using a linear elastic soil. The bottom of the mesh is best placed at a depth where the soil becomes notably harder. The distance from the bottom of the excavation to the hard layer, is called D_b . Lim and Briaud (1996) showed that when using a linear elastic soil in the simulation, D_b , had a linear influence on the vertical movement of the ground surface at the top of the wall, but comparatively very little influence on the horizontal movement of the wall face. For nearly all other analysis a value of D_b equals 1.2 times the height. This value of D_b was determined from an instrumented case history that used to calibrate the FEM model. Considering the parameters H , W_e , B_e and D_b as defined in Figure 6 – 19, it was found in a separate study (Lim and Briaud, 1996) that $W_e = 3D_e$ and $B_e = 3(H + D_b)$ were appropriate values for W_e and B_e ; indeed beyond these values, W_e and B_e have little influence on the horizontal deflection of the wall due to the excavation of the soil. This confirms previous findings by Dunlop and Duncan (1970).

It is possible to simulate the entire width of the wall in three dimensions. However, the size of the mesh would be prohibitively large. Instead, a repetitive section of the wall should be chosen for the simulation. Special moment restraints are required on the vertical edge boundaries of the wall to maintain a right angle in plan view between the displaced wall face and the sides of the simulated wall section; namely, a tensile force T_n and a moment M_b are induced as shown in Figure 6 – 19.

The general purpose code ABAQUS (ABAQUS 1992) can be used. The soldier piles and the tendon bonded length of the anchors can be simulated with beam elements; these are one-dimensional (1D) elements that can resist axial loads and bending moments. The stiffness for the pile elements is the EI and AE values of the soldier piles. These elements resist bending in the three directions. The tendon bonded length can be treated as a composite steel/grout section to get the EI and AE stiffness. The steel tendon in the tendon unbounded length of the anchor can be simulated as a spring element, this is a 1D element that can only resist axial load. This element is given a spring stiffness K equal to the initial slope of the load-displacement curve obtained in the anchor pullout tests. The soil can be simulated using various soil models (Duncan-Chang hyperbolic model, Cam Clay, Drucker-Prager, etc.)

The advantage of FEM over BEM/BMCO and hand calculations is that the method provides improved bending moment and deflection indications (Figure 6 – 20). The drawback is the need to use a computer program and an inability for the spring model to accurately represent the mass movement of the soil.

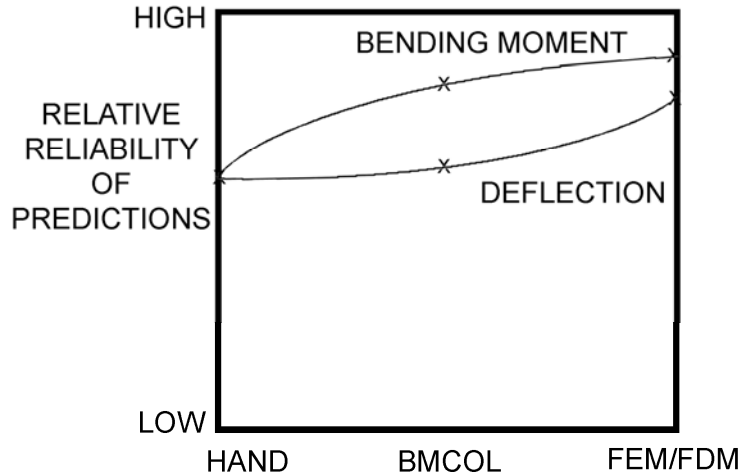

Figure 6 – 20. Comparison of Quality of Bending Moment and Deflection Results

6.10 VERTICAL CAPACITY OF WALL

6.10.1 Hand Methods

The vertical capacity of the wall is determined by summing the forces acting on the column (Equation 6 – 14). Figure 6 – 21 illustrates the forces acting on each soil cement column. The forces include:

$$V + W + q_n = \frac{r_w + r_b}{F} \quad (6 - 14)$$

where:

V is the vertical component of each anchor force

W is the weight of the repeatable section of the wall

q_n is the downdrag force from friction between the soil and the repeatable section of the wall

r_w is the resistance of the repeatable section of wall in positive friction

r_b is the resistance of the bottom of the repeatable section of wall

F is the chosen factor of safety

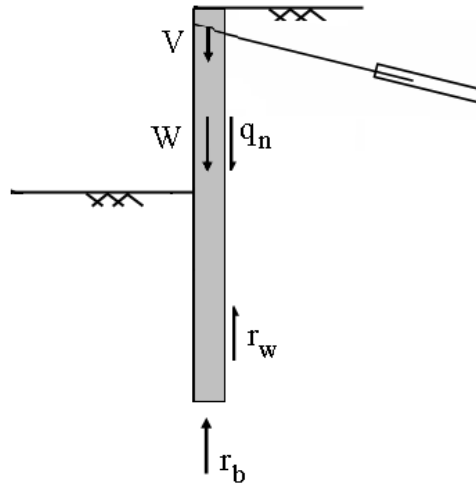

Figure 6 – 21. Vertical Capacity of Soil Cement Column

At the preliminary design stage, the length of wall over which the downdrag, q_n , acts may be taken equal to the excavation height. More accurate analysis require a computer aided analysis.

6.10.2 Computer Aided Analysis

Detailed guidelines for the downdrag problem are in Briaud and Tucker (1997) including a simple computer program which can be downloaded from the internet (<http://ceprofs.tamu.edu/briaud/pileneg.htm>).

6.11 STRUCTURAL RESISTANCE OF RETAINING ELEMENTS

The wall elements and anchor elements are designed in this step. The soil cement is designed to span between soldier beams similar to lagging in soldier beam/lagging walls (Taki and Yang, 1991). The stress analysis of soil cement between the reinforcement beams includes evaluation of internal shear and compression stress of the soil cement (Figure 6 – 22). The spacing between the reinforcement members is determined by ensuring safety against failure in bending and shear of both the steel beam and the soil cement (Pearlman and Himick, 1993). The shear strength at the section where columns intersect and at the flange of the beams is checked (Figure 6 – 23). The compressive stresses inside the soil cement block between the soldier beams are also calculated. Anchor design elements such as anchor type, corrosion protection, length, spacing, anchor resistance, bond length, and connection to retaining systems are determined following typical anchored wall design methodologies (Weatherby, 1998).

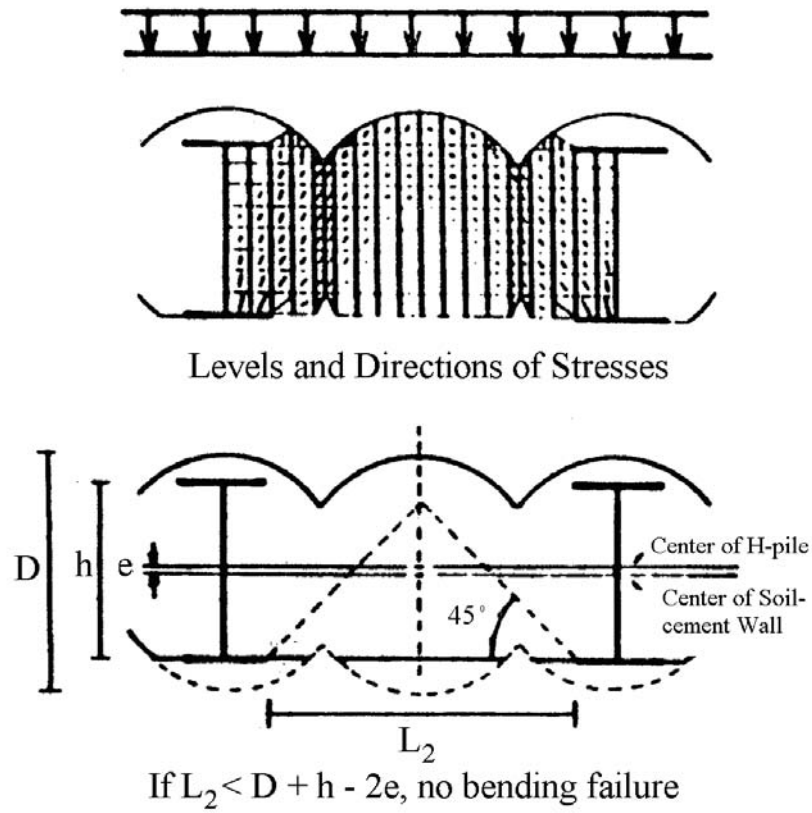

Figure 6 – 22. Stress Distribution in Soil Cement Wall (After Taki and Yang, 1991)

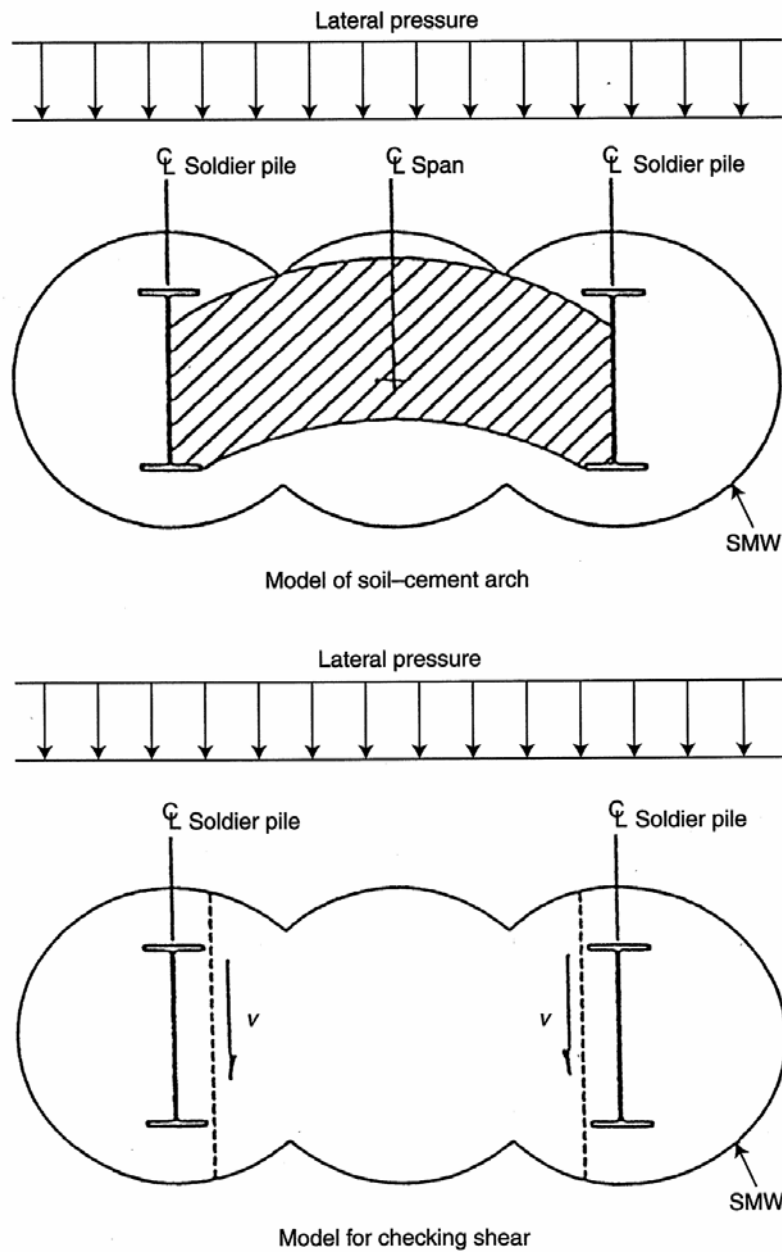

Figure 6 – 23. Soil Cement Arching and Shearing (After Porbaha, 2000)

6.12 MOVEMENTS

The design of excavation support systems is evolving towards a deflection based design. Movements of in situ wall systems are related to the stiffness of the system. Briaud and Lim (1999) illustrate how anchor load magnitude directly influence deflection and bending moments of tieback walls. Using the proposed k versus (u_{top}/H) relationships in Figure 6 – 13 and Figure 6 – 14, the engineer can select the anchor lock-off loads that will approximately generate a chosen deflection.

Another method of deflection based design is discussed by Clough and O'Rourke (1990). It relates wall and soil mass deformations to system stiffness and base stability. Deformations can be controlled within required limits by specifying design elements such as wall stiffness (EI), embedment depth of wall, and spacing of horizontal supports. The system stiffness, S , is determined from the wall stiffness, EI , and the spacing of the horizontal supports, h , as shown in Equation 6 – 15.

$$S = \frac{EI}{\gamma_w h^4} \quad (6 - 15)$$

where:

E is the modulus of elasticity of the wall

I is the moment of inertia of a unit length of wall

γ_w is the unit weight of water (included for normalization purposes)

h is the average spacing between supports

In soft to medium clays where movements are primarily due to the excavation and support process, Figure 6 – 24 can be used to estimate the maximum lateral wall movement once the factor of safety against base heave (section 6.4) has been determined and the system stiffness calculated

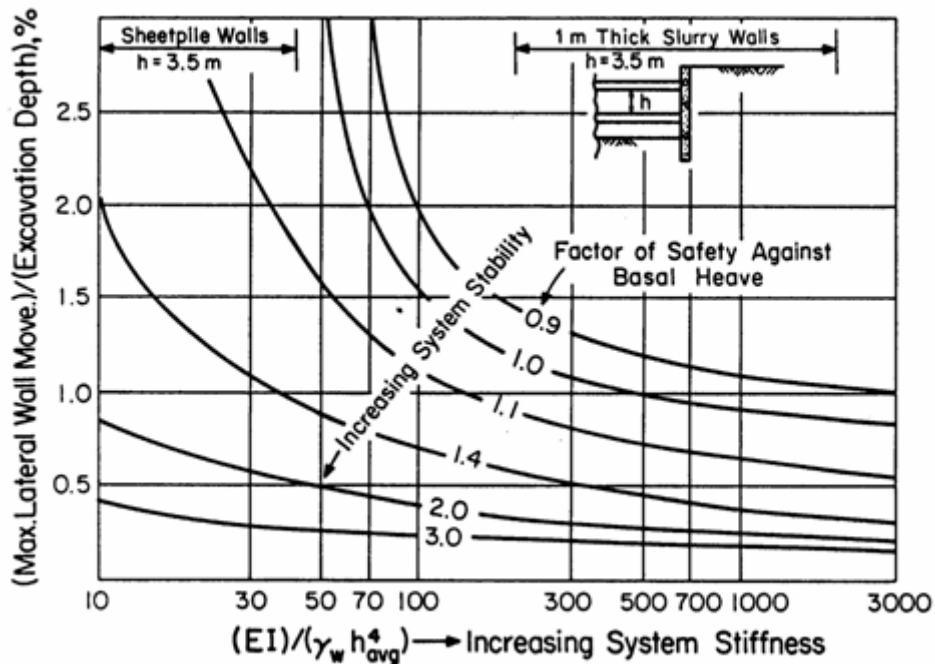

Figure 6 – 24. Design Curves to Obtain Maximum Lateral Wall Movement (or Soil Settlement) for Soft to Medium Clays (After Clough and O'Rourke, 1990)

Figure 6 – 25 provides dimensionless settlement profiles for estimating the distribution of settlement adjacent to excavations in different soil types. The maximum soil settlement is taken

as being approximately equal to the maximum horizontal wall movement (Clough and O'Rourke, 1990).

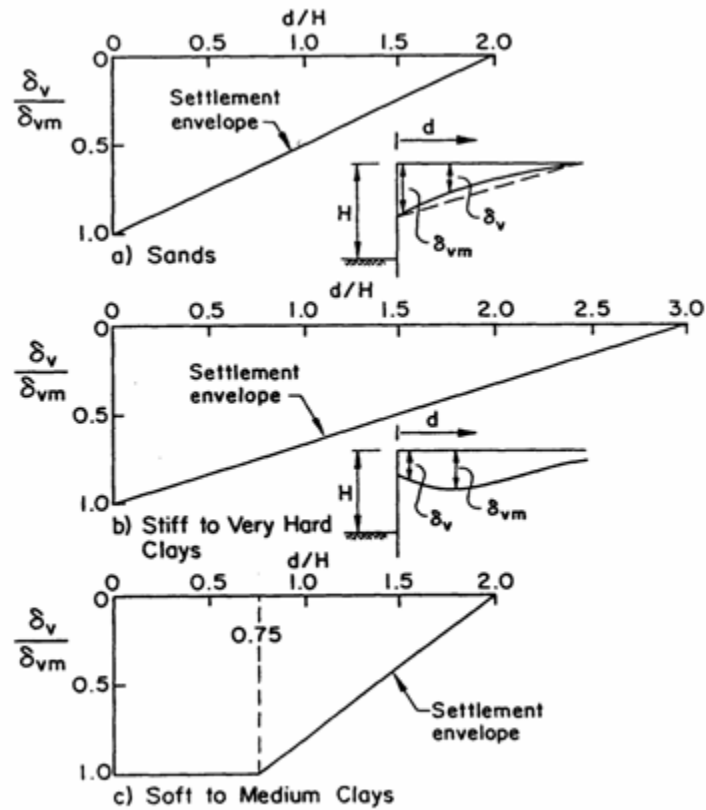

Figure 6 – 25. Dimensionless Settlement Profiles Recommended for Estimating the Distribution of Settlement Adjacent to Excavations in Different Soil Types (After Clough and O'Rourke, 1990)

Figure 6 – 26 and Figure 6 – 27 show observed maximum lateral movements for in situ walls in stiff clays, residual soils and sands and predicted maximum lateral wall movements by finite element analysis modeling stiff soil conditions, respectively.

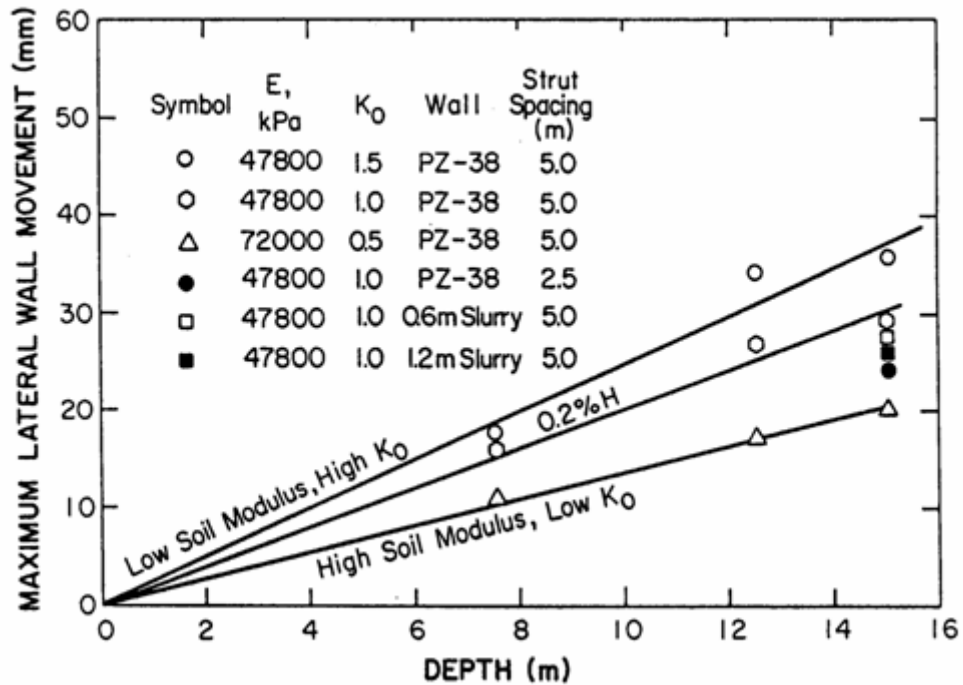

Figure 6 – 27. Predicted Maximum Lateral Wall Movements by Finite Element Analysis Modeling Stiff Soil Conditions (After Clough and O'Rourke, 1990)

6.13 OTHER CONSIDERATIONS

Seismic loading is not typically accounted for when the excavation support is intended to be a temporary shoring system. Temporary support systems have been shown to be flexible enough that little or no damage occurs in moderate seismic events (McNab, 2002). When the excavation support is to be incorporated into the permanent structure or used for permanent earth retention, seismic conditions should be considered. Settlement should be also accounted for when the excavation support will be a permanent structure. Freeze-thaw durability of deep mix wall should be considered for permanent applications. For temporary use, chain length fences need to be placed to prevent injury to workers (Tamaro, 2003).

CHAPTER 7

DESIGN EXAMPLES

7.1 INTRODUCTION

The following design examples provided detailed calculation for cantilever and single support/tieback walls. The cases were chosen to illustrate the design method using simplified soil profiles. The design examples will follow the design flowchart shown previously in Figure 6 – 3 and the hand method steps discussed in Chapter 6.

7.2 DESIGN EXAMPLE – CANTILEVER WALL

The cases for the cantilever wall examples are summarized in Table 7 – 1. The first case illustrates the design of the wall in a uniform sand of infinite depth with the given soil parameters. Each case is divided into two sub-cases, (a) and (b). Case 1a, for example, would be the design of the wall in uniform sand with no water present, whereas, Case 1b would have water at the surface of the excavation and wall. Case 2a and Case 2b illustrate a site consisting of uniform clay deposits. Case 3a and Case 3b provide examples where clay overlies a deposit of sand causing a potential “plug heave” failure.

Table 7 – 1. Cantilever Design Example Cases

Cases	Soil Parameters	A	B
1 – uniform sand infinite depth	$\gamma_t = 18 \text{ kN/m}^3$; $\phi = 32^\circ$	no water	water at surface
2 – uniform clay	$\gamma_t = 20 \text{ kN/m}^3$; $\phi = 32^\circ$; $c = 10 \text{ kPa}$	no water	water at surface
3 – clay over sand	same as sand and clay above	no water	water at surface

7.2.1 Cantilever Wall – Case 1a

STEP 1: Site Investigation – Uniform sand infinite depth with no water.

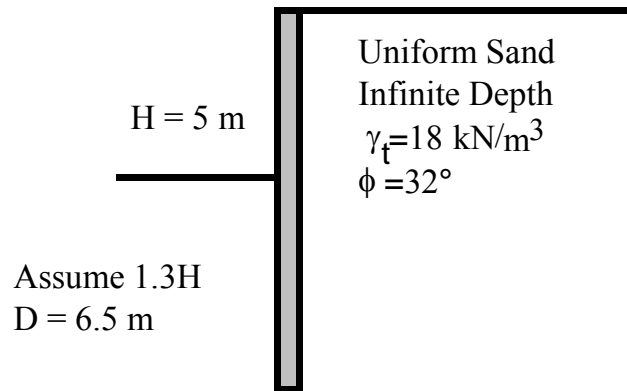

Figure 7 – 1. Cross Section of Cantilever with Soil Properties (Case 1a)

STEP 2: Project Parameters – The initial wall geometry is assumed base on project requirements. An initial estimate of the embedment depth, D , can be assumed as $D = 1.3H$ where H is the height of the excavation (Figure 7 – 1).

STEP 3: Seepage Analysis – A seepage analysis is not required because water is not present.

STEP 4: External Stability – Base stability analysis is determined using a circular slip failure analysis as shown in Figure 7 – 2.

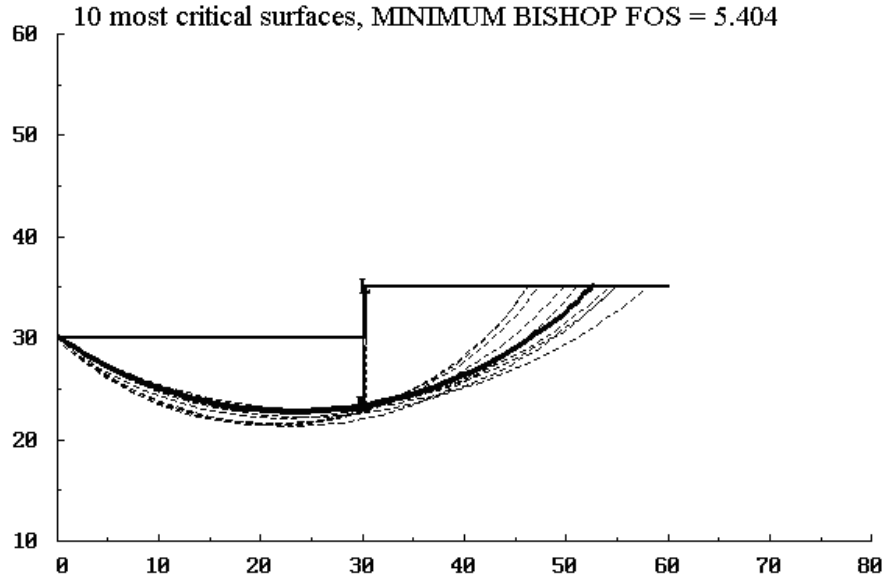

Figure 7 – 2. Base Stability for Cantilever Wall (Case 1a)

STEP 5a: Earth Pressures – The earth pressures are calculated per meter of wall. The active and passive earth pressures are calculated using the following Equations (7 – 1 through 7 – 9).

Active

$$\sigma_{ov} = \gamma_t \text{ depth} \quad (7-1)$$

$$u_o = 0 \quad (7-2)$$

$$\sigma'_{ov} = \sigma_{ov} - u_o \quad (7-3)$$

$$\sigma'_{ah} = K_a \sigma'_{ov} \quad (7-4)$$

$$\sigma_{ah} = \sigma'_{ah} - 2c\sqrt{K_a} + K_a \Delta \sigma'_{ov} + \alpha u_o \quad (7-5)$$

$$P_a = \frac{1}{2} \times \sigma_{ah\max} \times \text{depth} \quad (7-6)$$

Passive

$$\sigma_{ov} = \gamma_t \text{ depth}$$

$$u_o = 0$$

$$\sigma'_{ov} = \sigma_{ov} - u_o$$

$$\sigma'_{ph} = K_p \sigma'_{ov} \quad (7-7)$$

$$\sigma_{ph} = \sigma'_{ph} + 2c\sqrt{K_p} + K_p \Delta \sigma'_{ov} + \alpha u_o \quad (7-8)$$

$$P_p = \frac{1}{2} \times \sigma_{ph\max} \times \text{depth} \quad (7-9)$$

Table 7 – 2 shows the active, passive, and kickback values determined after optimizing the embedment depth. Figure 7 – 3 illustrates the active and passive earth pressures on the wall.

Table 7 – 2. Earth Pressure and Kickback Force Calculations (Case 1a)

(a) Active Earth Pressure Calculations

Depth (m)	σ_{ov} (kPa)	u_o (kPa)	σ'_{ov} (kPa)	σ'_{ah} (kPa)	σ_{ah} (kPa)	P_a (kN/m)
0	0	0	0	0	0	301.15
5	90	0	90	27.63	27.63	
10.44	187.92	0	187.92	57.69	57.69	

(b) Passive Earth Pressure Calculations

Depth (m)	σ_{ov} (kPa)	u_o (kPa)	σ'_{ov} (kPa)	σ'_{ph} (kPa)	σ_{ph} (kPa)	P_p (kN/m)
0	0	0	0	0	0	866.94
5.44	97.92	0	97.92	318.73	318.73	

(c) Kick Back Force Calculations

P_a (kN/m)	P_p (kN/m)	P_p/F (kN/m)	R (kN/m)
301.15	866.94	577.96	276.81

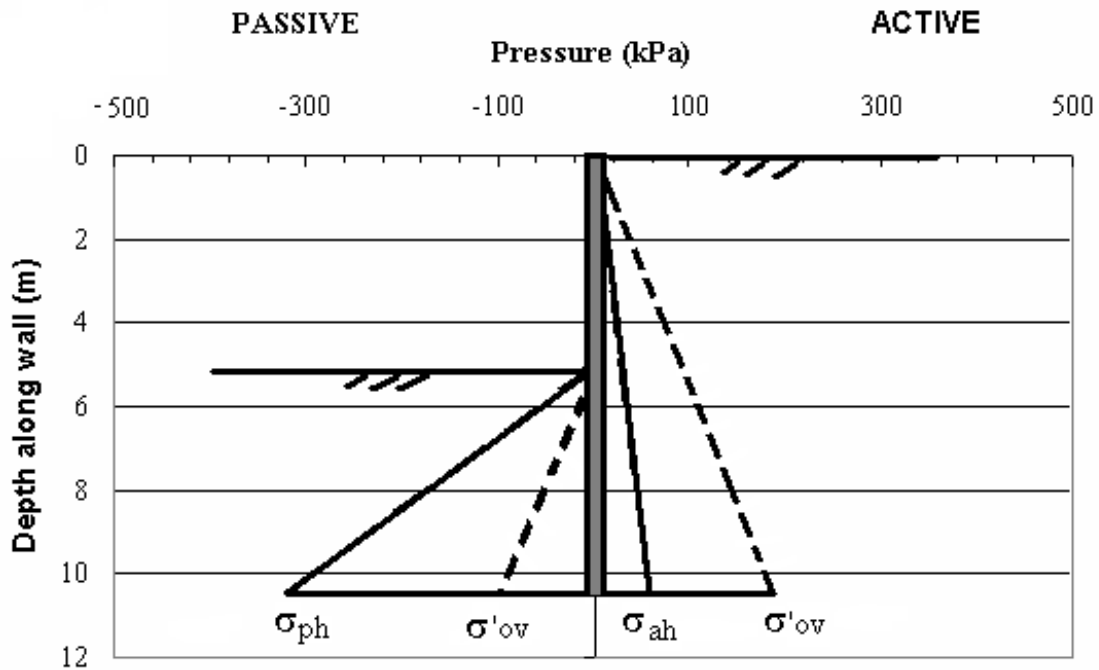

Figure 7 – 3. Active and Passive Earth Pressure Diagrams (Case 1a)

STEP 5b: Required Embedment Depth – The required embedment depth, D , is determined as described in section 6.6. The factor of safety against overturning, $F_{\text{overturning}}$, and the factor of safety against translation, $F_{\text{translation}}$, are determined using Equations 7 – 10 and 7 – 11. Trial and error allows for the embedment depth at $F_{\text{overturning}}=1.5$ to be determined. Table 7 – 3 compares the factors of safety for each trial embedment depth. Figure 7 – 4 shows the final dimensions of the cantilever wall for case 1a, a uniform sand deposit without water.

$$F_{\text{overturning}} = \frac{P_p \left(\frac{D}{3} \right)}{P_a \left(\frac{1}{3} (H + D) \right)} \quad (7 - 10) \qquad F_{\text{translation}} = \frac{P_p}{P_a} \quad (7 - 11)$$

where:

- $F_{\text{overturning}}$ is the factor of safety against overturning
- P_p is the resultant of the passive earth pressure
- P_a is the resultant of the active earth pressure
- D is the embedment depth
- H is the height of the wall
- $F_{\text{translation}}$ is the factor of safety against translation

Table 7 – 3. Factor of Safety Calculations for Various Embedment Depths (Case 1a)

Trail Embedment Depth, D	$FS_{\text{overturning}}$	$FS_{\text{translation}}$
6.50 m	1.92	3.39
6.00 m	1.72	3.15
5.50 m	1.52	2.91
5.44 m	1.50	2.88

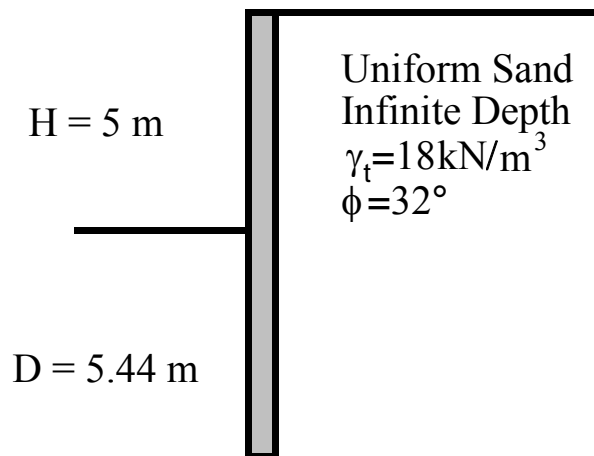
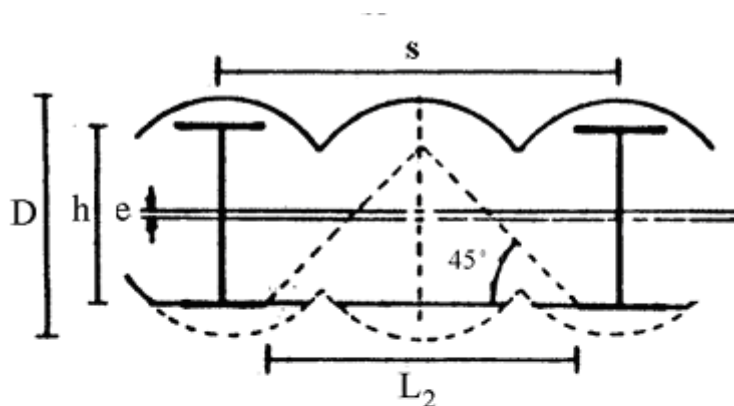

Figure 7 – 4. Final Dimensions of Wall (Case 1a)

STEP 5c: Maximum Bending Moment – The shear and bending moment diagrams are drawn to determine the maximum bending moment using traditional structural analysis. Once the maximum moment has been determined, the structural section can be selected for the reinforcement.

STEP 6: Vertical Capacity of Wall – The downdrag on the wall is determined using procedures discussed in section 6.10 and is not illustrated here.

STEP 7: Structural Resistance of Retaining Elements – The failure of the columns in bending and shear must be checked as described in section 6.11. For example, the bending failure and shear failure are checked as shown in Figure 7 – 5 and Figure 7 – 6, respectively.



If $L_2 < D + h - 2e$, no bending failure

Assume W60x124 (W24x84) steel reinforcement and $e = 0$.

Beam spacing, $s = 48"$

Diameter, $D = 36"$

Height of beam, $h = 24.09"$

Width of beam, $b = 9.01"$

$L = s - b = 48" - 9.01" = 38.99"$

$D + h - 2e = 36" + 24.09" = 60.09"$

$38.99" < 60.09"$ therefore no bending failure.

Figure 7 – 5. Bending Failure Check (After Taki and Yang, 1991)

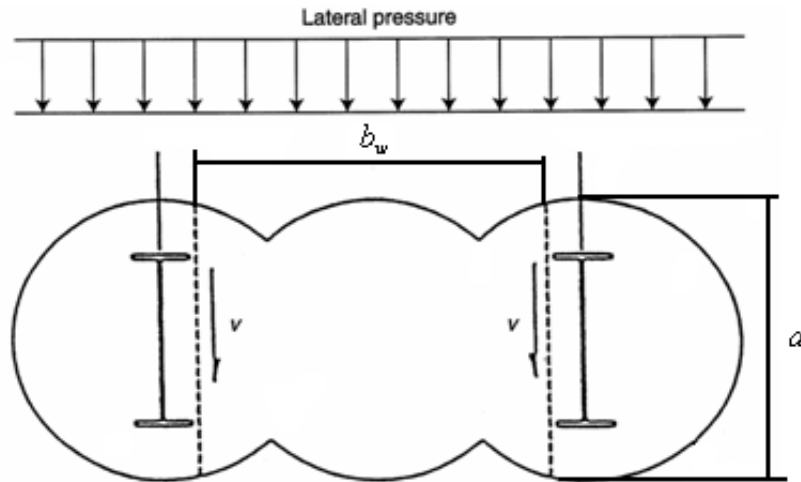

Using American Concrete Institute (ACI) equation 11.3 for nominal shear strength:

$$V_c = \lambda 2\sqrt{f'_c} b_w d$$

where λ for lightweight concrete is estimated as 0.75

f'_c for soil cement is assumed to be 2,000 kPa = 290.075 psi

b_w is the width of the block

d is the height of the block

Therefore,

$$V_c = 0.75 \sqrt{290.075 \text{ psi}} (38.99") (36")$$

$$V_c = 35,859.33 \text{ lb} = 159.51 \text{ kN}$$

$$V_{\text{max}} < V_c = 159.51 \text{ kN}$$

Figure 7 – 6. Shear Failure Check (After Porbaha, 2000)

STEP 8: Movements – Deflection based design will be illustrated for single tieback/support walls.

STEP 9: Other Considerations – See section 6.13 for additional considerations for design.

7.2.2 Cantilever Wall – Case 1b

STEP 1: Site Investigation Uniform sand infinite depth with water at surface (Figure 7 – 7).

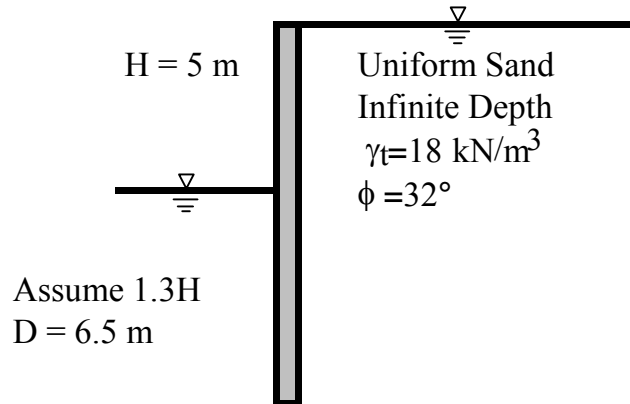

Figure 7 – 7. Cross Section of Cantilever with Soil Properties (Case 1b)

STEP 2: Project Parameters – The initial wall geometry is assumed based on project requirements. An initial estimate of the embedment depth, D , can be assumed as $D = 1.3H$ where H is the height of the excavation (Figure 7 – 7).

STEP 3: Seepage Analysis – A seepage analysis is required to determine the pore pressures behind the retaining wall. A flownet must be drawn for each trial embedment to determine the final embedment depth. The factor of safety against quick condition, FS_{quick} , is determined by dividing the critical gradient, i_{cr} , by the exit gradient, i_{exit}

$$i_{cr} = \frac{\gamma_{sat} - \gamma_w}{\gamma_w} \quad (7 - 12)$$

where:

γ_{sat} is the saturated unit weight of the soil

γ_w is the unit weight of water

Therefore,

$$i_{cr} = \frac{18 \frac{\text{kN}}{\text{m}^3} - 9.81 \frac{\text{kN}}{\text{m}^3}}{9.81 \frac{\text{kN}}{\text{m}^3}} = 0.835$$

The exit gradient is calculated using Equation 7 – 13.

$$i_{exit} = \frac{\Delta h}{L_{min}} \quad (7 - 13)$$

where:

Δh is defined using Equation 7 – 14.

L_{min} is the minimum length of flow over which the loss of head occurs

$$\Delta h = \frac{\Delta H}{N_d} \quad (7 - 14)$$

where:

ΔH is the difference between the water levels

N_d is the total number of drops

Therefore,

$$i_{exit} = \frac{.42m}{1.25m} = 0.336$$

Thus, the factor of safety against quick condition, FS_{quick} , is calculated using Equation 7 – 15.

$$FS_{quick} = \frac{i_{cr}}{i_{exit}} = \frac{0.835}{0.336} = 2.48 \quad (7 - 15)$$

STEP 4: External Stability – Base stability analysis is determined using a circular slip failure analysis as shown in Figure 7 – 8.

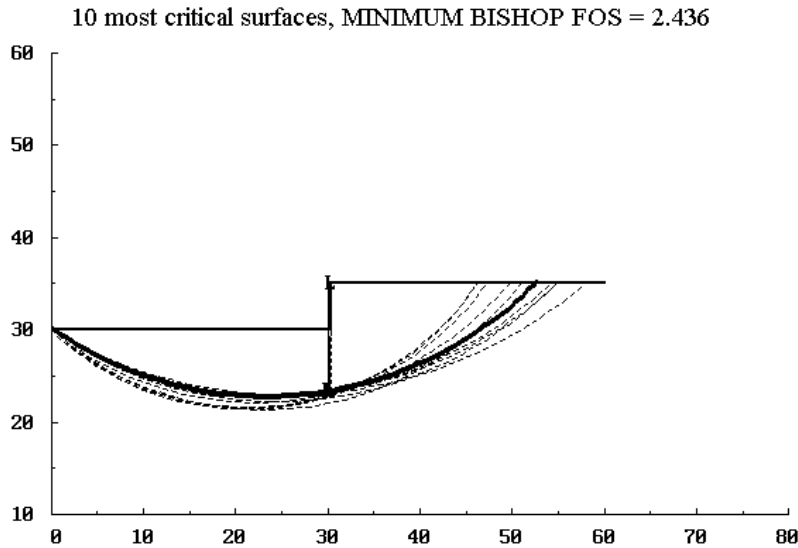

Figure 7 – 8. Base Stability for Cantilever Wall (Case 1b)

STEP 5a: Earth Pressures – The earth pressures are calculated per meter of wall using Equations 7 – 1 through 7 – 9. The pore pressures are determined from the seepage analysis. Table 7 – 4 shows the active, passive, and kickback values determined for an embedment depth of 6.5 m. Figure 7 – 9 illustrates the active and passive earth pressures on the wall.

Table 7 – 4. Earth Pressure and Force Calculations (Case 1b)

(a) Active Earth Pressure Calculations

Depth (m)	σ_{ov} (kPa)	u_o (kPa)	σ'_{ov} (kPa)	σ'_{ah} (kPa)	σ_{ah} (kPa)	P_a (kN/m)
0	0	0	0	0	0	794.60
6.25	112.5	68.57	43.93	13.49	82.06	
11.5	207	107.71	99.29	30.48	138.19	

(b) Passive Earth Pressure Calculations

Depth (m)	σ_{ov} (kPa)	u_o (kPa)	σ'_{ov} (kPa)	σ'_{ph} (kPa)	σ_{ph} (kPa)	P_p (kN/m)
0	0	0	0	0	0	508.72
3.5	63	59.35	3.65	11.88075	71.23075	
6.5	117	99.47	17.53	57.06	156.53	

(c) Force Calculations

P_a (kN/m)	P_p (kN/m)	P_p/F (kN/m)	R (kN/m)
794.60	508.72	804.9414359	10.34

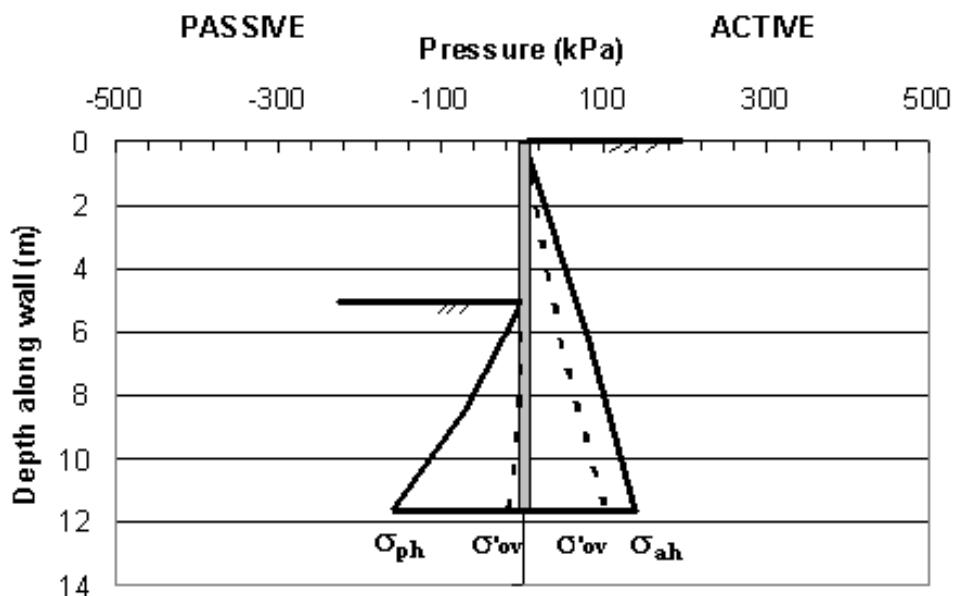

Figure 7 – 9. Active and Passive Pressure Diagrams (Case 1b)

STEP 5b: Required Embedment Depth – The required embedment depth, D , is determined as described in section 6.6. The factor of safety against overturning, $F_{overturning}$, and the factor of safety against translation, $F_{translation}$, are determined using Equations 7 – 10 and 7 – 11. Table 7 – 5 shows the factors of safety for embedment depth, $D = 6.5$ m. Trial and error allows for the embedment depth at $F_{overturning}=1.5$ to be determined.

Table 7 – 5. Factor of Safety Calculations (Case 1b)

Trail Embedment Depth, D	$FS_{overturning}$	$FS_{translation}$
6.50 m	0.36	0.64

STEP 5c: Maximum Bending Moment – The shear and bending moment diagrams are drawn to determine the maximum bending moment using traditional structural analysis.

STEP 6: Vertical Capacity of Wall – The downdrag on the wall is determined using procedures discussed in section 6.10 and is not illustrated here.

STEP 7: Structural Resistance of Retaining Elements – The failure of the columns in bending and shear must be checked as described in section 6.11.

STEP 8: Movements – Deflection based design will be illustrated for single tieback/support walls.

STEP 9: Other Considerations – See section 6.13 for additional considerations for design.

7.2.3 Cantilever Wall – Case 2a

STEP 1: Site Investigation – Uniform clay with no water (Figure 7 – 10).

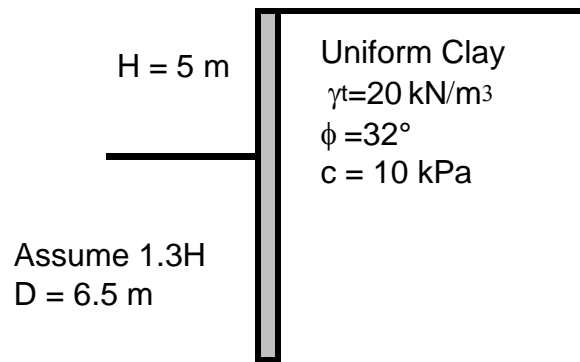

Figure 7 – 10. Cross Section of Cantilever with Soil Properties (Case 2a)

STEP 2: Project Parameters – The initial wall geometry is assumed based on project requirements. An initial estimate of the embedment depth, D , can be assumed as $D = 1.3H$ where H is the height of the excavation (Figure 7 – 10).

STEP 3: Seepage Analysis – A seepage analysis is not required because water is not present.

STEP 4: External Stability – Base stability analysis is determined using a circular slip failure analysis as shown in Figure 7 – 11.

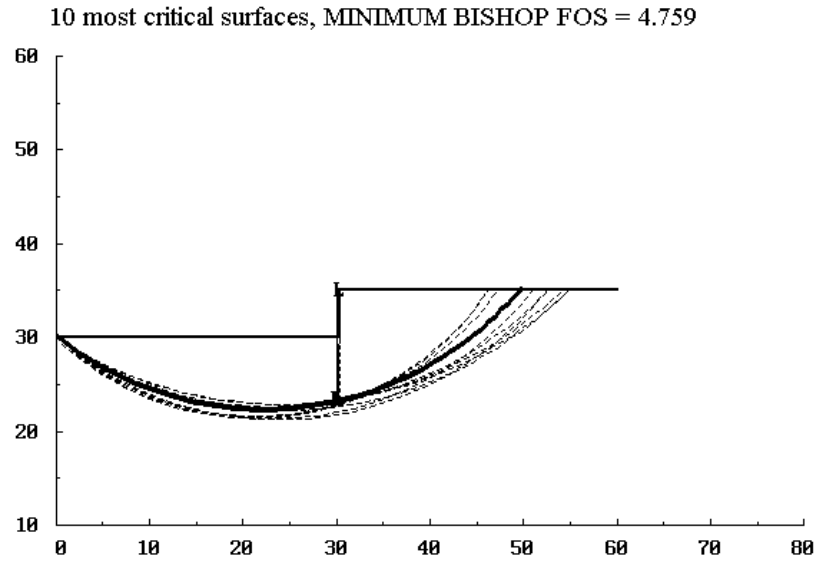

Figure 7 – 11. Base Stability Cantilever Wall (Case 2a)

STEP 5a: Earth Pressures – Effective Stress Analysis – The earth pressures are calculated per meter of wall using Equations 7 – 1 through 7 – 9. Table 7 – 6 shows the active, passive, and kickback values determined after optimizing the embedment depth. Figure 7 – 12 illustrates the active and passive earth pressures on the wall.

Table 7 – 6. Earth Pressure and Force Calculations (Case 2a)

(a) Active Earth Pressure Calculations

Depth (m)	σ_{ov} (kPa)	u_o (kPa)	σ'_{ov} (kPa)	σ'_{ah} (kPa)	σ_{ah} (kPa)	P_a (kN/m)
0	0	0	0	0	0	252.15
5	100	0	100	30.70	19.62	
10.01	200.2	0	200.2	61.46	50.38	

(b) Passive Earth Pressure Calculations

Depth (m)	σ_{ov} (kPa)	u_o (kPa)	σ'_{ov} (kPa)	σ'_{ph} (kPa)	σ_{ph} (kPa)	P_p (kN/m)
0	0	0	0	0	0	907.40
5.01	100.2	0	100.2	326.15	362.23	

(c) Force Calculations

P_a (kN/m)	P_p (kN/m)	P_p/F (kN/m)	R (kN/m)
252.15	907.40	604.93	352.78

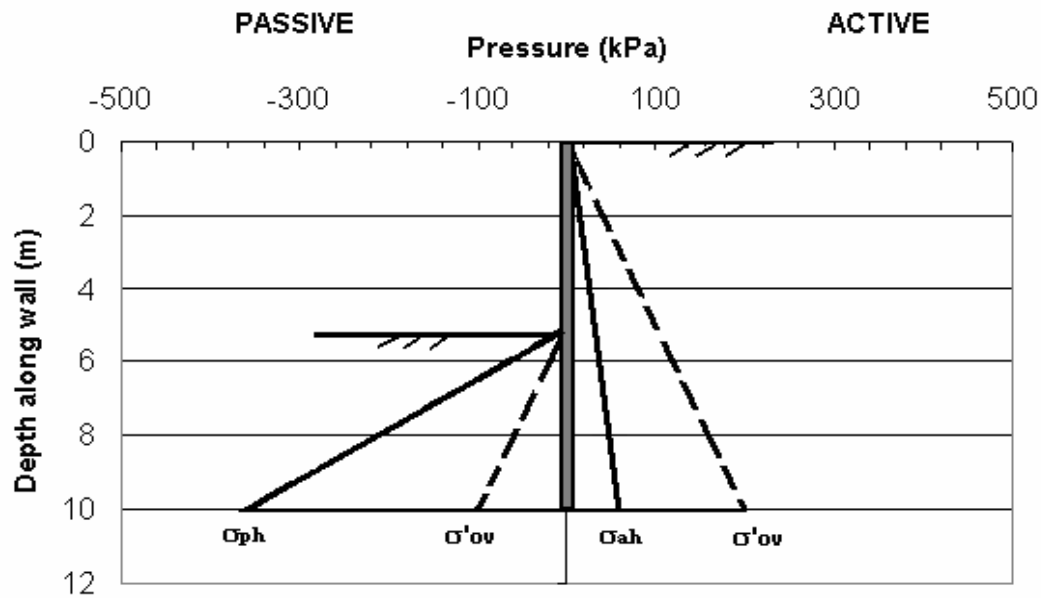

Figure 7 – 12. Active and Passive Earth Pressure Diagrams (Case 2a)

STEP 5b: Required Embedment Depth – The required embedment depth, D , is determined as described in section 6.6. The factor of safety against overturning, $F_{overturning}$, and the factor of safety against translation, $F_{translation}$, are determined using Equations 7 – 10 and 7 – 11. Trial and error allows for the embedment depth at $F_{overturning}=1.5$ to be determined. Table 7 – 7 compares the factors of safety for each trial embedment depth. Figure 7 – 13 shows the final dimensions of the cantilever wall for case 2a, a uniform clay deposit without water.

Table 7 – 7. Factor of Safety Calculations for Various Embedment Depths (Case 2a)

Trail Embedment Depth, D	$FS_{overturning}$	$FS_{translation}$
6.50 m	2.01	4.36
6.00 m	1.90	4.12
5.50 m	1.70	3.87
5.01 m	1.50	3.60

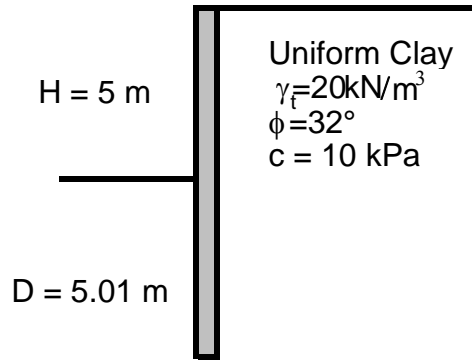

Figure 7 – 13. Final Dimensions of Wall Using Effective Stress Analysis (Case 2a)

STEP 5c: Maximum Bending Moment – The shear and bending moment diagrams are drawn to determine the maximum bending moment using traditional structural analysis.

STEP 6: Vertical Capacity of Wall – The downdrag on the wall is determined using procedures discussed in section 6.10 and is not illustrated here.

STEP 7: Structural Resistance of Retaining Elements – The failure of the columns in bending and shear must be checked as described in section 6.11.

STEP 8: Movements – Deflection based design will be illustrated for single tieback/support walls.

STEP 9: Other Considerations – See section 6.13 for additional considerations for design.

7.2.4 Cantilever Wall – Case 2b

STEP 1: Site Investigation – Uniform clay with water at surface (Figure 7 – 14).

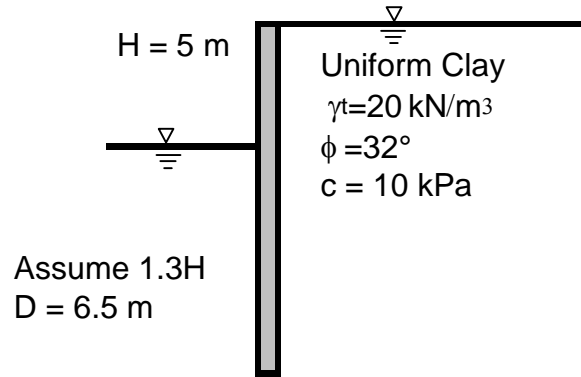

Figure 7 – 14. Cross Section of Cantilever with Soil Properties (Case 2b)

STEP 2: Project Parameters – The initial wall geometry is assumed base on project requirements. An initial estimate of the embedment depth, D , can be assumed as $D = 1.3H$ where H is the height of the excavation (Figure 7 – 14).

STEP 3: Seepage Analysis – A seepage analysis is required to determine the pore pressures behind the retaining wall. The factor of safety against quick condition, FS_{quick} , is determined by dividing the critical gradient, i_{cr} , by the exit gradient, i_{exit} . The critical gradient is calculated using Equation 7 – 12. Therefore,

$$i_{cr} = \frac{20 \frac{\text{kN}}{\text{m}^3} - 9.81 \frac{\text{kN}}{\text{m}^3}}{9.81 \frac{\text{kN}}{\text{m}^3}} = 1.039$$

The exit gradient is calculated using Equation 7 – 13. Therefore,

$$i_{exit} = \frac{.42\text{m}}{1.25\text{m}} = 0.336$$

The factor of safety against quick condition is calculated using Equation 7 – 14. Therefore,

$$FS_{quick} = \frac{i_{cr}}{i_{exit}} = \frac{1.039}{0.336} = 3.09$$

Bottom heave is calculated following methods shown in Appendix A, Figure A – 3 (NAVFAC DM 7.1, 1982). Therefore,

$$FS = \frac{N_c c}{\gamma_t H + q} = \frac{(7.5)(10kPa)}{(20 \frac{kN}{m^3})(5m)} = 0.62 < 1.5$$

The wall must extend below the bottom of the excavation past the depth of $\frac{B}{\sqrt{2}} = 3.54$ m. The preliminary embedment depth, $D = 6.5$ m.

STEP 4: External Stability – Base stability analysis is determined using a circular slip failure analysis as shown in Figure 7 – 15.

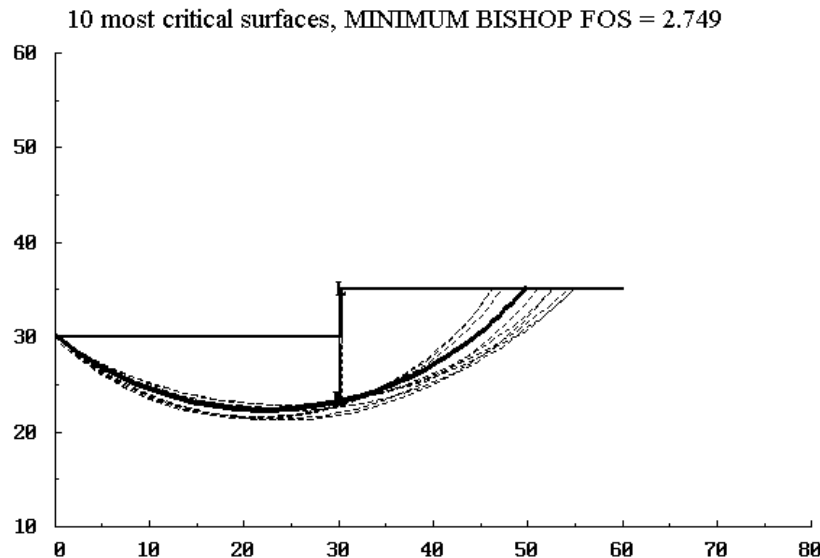

Figure 7 – 15. Base Stability for Cantilever Wall (Case 2b)

STEP 5a: Earth Pressures – Effective Stress Analysis – The earth pressures are calculated per meter of wall. The active and passive earth pressures for an effective stress analysis are calculated using Equations 7 – 1 through 7 – 9. The pore pressures are determined from the seepage analysis.

Table 7 – 8 shows the active, passive, and kickback values determined for embedment depth, $D = 6.5$ m. Figure 7 – 16 illustrates the active and passive earth pressures on the wall for an effective stress analysis.

Table 7 – 8. Earth Pressure and Force Using Effective Stress Analysis (Case 2b)

(a) Active Earth Pressure Calculations

Depth (m)	σ_{ov} (kPa)	u_o (kPa)	σ'_{ov} (kPa)	σ'_{ah} (kPa)	σ_{ah} (kPa)	P_a (kN/m)
0	0	0	0	0	0	771.49
6.25	125	68.57	56.43	17.32	74.81	
11.5	230	107.71	122.29	37.54	134.17	

(b) Passive Earth Pressure Calculations

Depth (m)	σ_{ov} (kPa)	u_o (kPa)	σ'_{ov} (kPa)	σ'_{ph} (kPa)	σ_{ph} (kPa)	P_p (kN/m)
0	0	0	0	0	0	763.52
3.5	63	59.35	3.65	11.88	71.23	
6.5	130	99.47	30.53	99.38	234.93	

(c) Force Calculations

P_a (kN/m)	P_p (kN/m)	P_p/F (kN/m)	R (kN/m)
771.49	763.52	1365.86	594.38

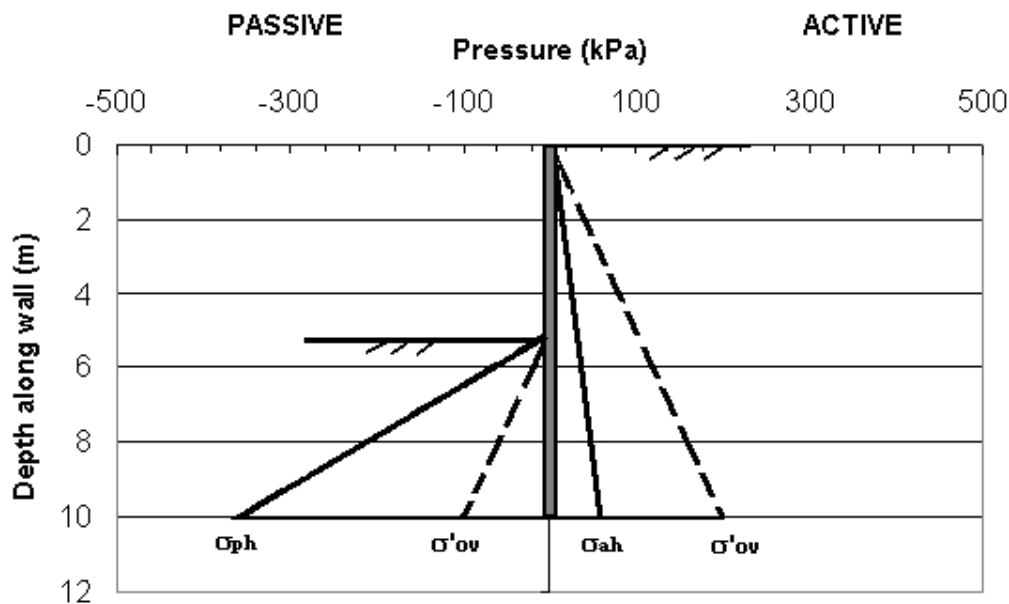

Figure 7 – 16. Active and Passive Diagrams Using Effective Stress Analysis for Cantilever Wall (Case 2b)

Undrained Total Stress Analysis – For fine-grained soil and short-term excavations, an undrained total stress analysis is also used to calculate the active and passive earth pressures on the wall using Equations 7 – 12 through 7 – 16. Table 7 – 9 shows the active, passive, and

kickback values determined after optimizing the embedment depth. Figure 7 – 17 illustrates the active and passive earth pressures on the wall for a total stress analysis.

Active

$$\sigma_{ov} = \gamma_t \text{ depth} \quad (7-12)$$

$$\sigma_{ah} = \sigma_{ov} + \Delta\sigma_{ov} - 2S_u \quad (7-13)$$

$$P_a = \frac{1}{2} \times \sigma_{ah\max} \times \text{depth} \quad (7-14)$$

Passive

$$\sigma_{ov} = \gamma_t \text{ depth}$$

$$\sigma_{ph} = \sigma_{ov} + \Delta\sigma_{ov} + 2S_u \quad (7-15)$$

$$P_p = \frac{1}{2} \times \sigma_{ph\max} \times \text{depth} \quad (7-16)$$

Table 7 – 9. Earth Pressure and Force Calculations Using Total Stress Analysis (Case 2b)

(a) Active Earth Pressure Calculations

Depth (m)	σ_{ov} (kPa)	σ_{ah} (kPa)	P_a (kN/m)
0	0	0	1035.00
6.25	125	75	
11.5	230	180	

(b) Passive Earth Pressure Calculations

Depth (m)	σ_{ov} (kPa)	σ_{ph} (kPa)	P_p (kN/m)
0	0	0	585.00
3.5	63	113	
6.5	130	180	

(c) Force Calculations

P_a (kN/m)	P_p (kN/m)	P_p/F (kN/m)	R (kN/m)
1035.00	585.00	1828.13	793.13

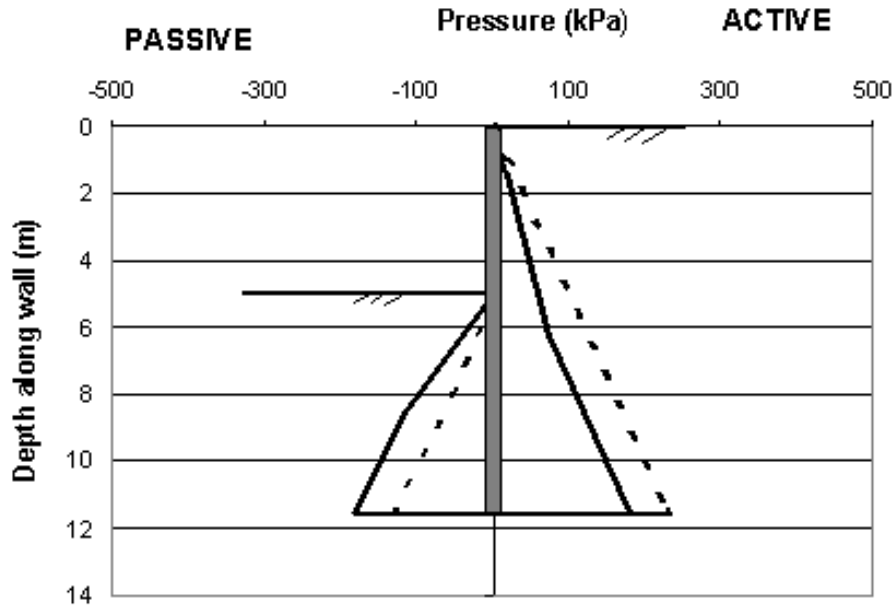

Figure 7 – 17. Active and Passive Diagrams Using Undrained Total Stress Analysis for Cantilever Wall (Case 2b)

STEP 5b: Required Embedment Depth – The required embedment depth, D , is determined as described in section 6.6. The factor of safety against overturning, $F_{overturning}$, and the factor of safety against translation, $F_{translation}$, are determined using Equations 7 – 10 and 7 – 11. Trial and error allows for the embedment depth at $F_{overturning}=1.5$ to be determined. Table 7 – 10 and Table 7 – 11 compare the factors of safety for embedment depth, $D = 6.5$ m, for the effective stress and total stress analyses. The embedment depth should be changed until the $F_{overturning}$ and $F_{translation}$ are satisfactory.

Table 7 – 10. Factor of Safety Calculations Using Effective Stress Analysis (Case 2b)

Trail Embedment Depth, D	$FS_{overturning}$	$FS_{translation}$
6.50 m	0.559	0.999

Table 7 – 11. Factor of Safety Calculations Using Total Stress Analysis (Case 2b)

Trail Embedment Depth, D	$FS_{overturning}$	$FS_{translation}$
6.50 m	0.319	0.565

STEP 5c: Maximum Bending Moment – The shear and bending moment diagrams are drawn to determine the maximum bending moment – using traditional structural analysis.

STEP 6: Vertical Capacity of Wall – The downdrag on the wall is determined using procedures discussed in section 6.10 and is not illustrated here.

STEP 7: Structural Resistance of Retaining Elements – The failure of the columns in bending and shear must be checked as described in section 6.11.

STEP 8: Movements – Deflection based design will be illustrated for single tieback/support walls.

STEP 9: Other Considerations – See section 6.13 for additional considerations for design.

7.2.5 Cantilever Wall – Case 3a

STEP 1: Site Investigation – Clay over sand with no water (Figure 7 – 18).

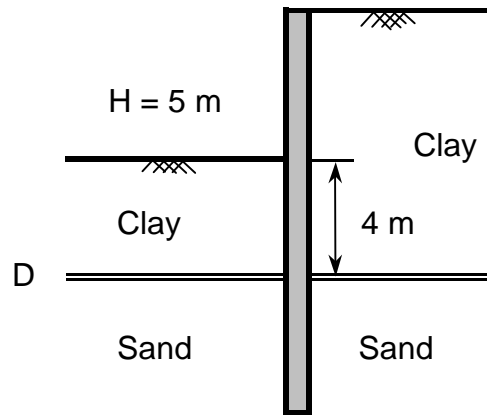

Figure 7 – 18. Cross Section of Cantilever with Soil Properties (Case 3a)

STEP 2: Project Parameters – The initial wall geometry is assumed based on project requirements. An initial estimate of the embedment depth, D , can be assumed as $D = 1.3H$ where H is the height of the excavation (Figure 7 – 18).

STEP 3: Seepage Analysis – A seepage analysis is not required because water is not present.

STEP 4: External Stability – Base stability analysis is determined using a circular slip failure analysis as shown in Figure 7 – 19.

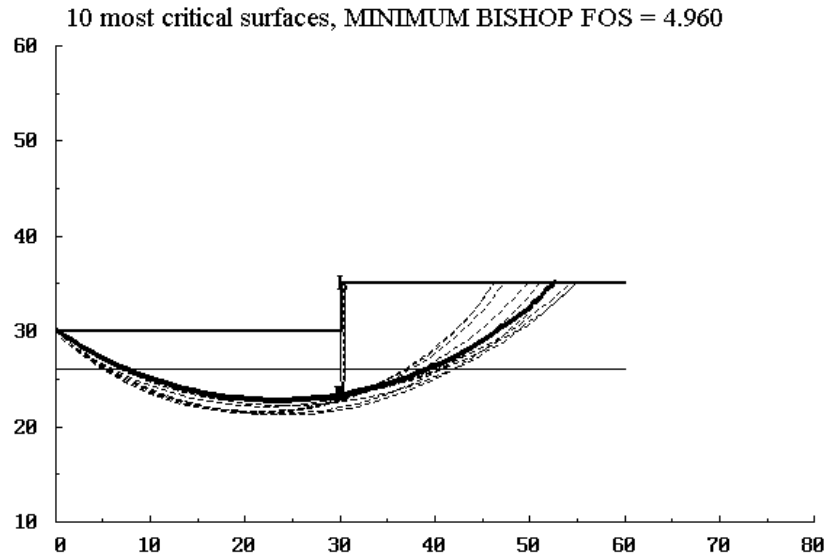

Figure 7 – 19. Base Stability for Cantilever Wall (Case 3a)

STEP 5a: Earth Pressures – The earth pressures are calculated per meter of wall using Equations 7 – 1 through 7 – 9. Table 7 – 12 shows the active, passive, and kickback values determined after optimizing the embedment depth. Figure 7 – 20 illustrates the active and passive earth pressures on the wall.

Table 7 – 12. Earth Pressure and Force Calculations (Case 3a)

(a) Active Earth Pressure Calculations

Depth (m)	σ_{ov} (kPa)	u_o (kPa)	σ'_{ov} (kPa)	σ'_{ah} (kPa)	σ_{ah} (kPa)	P_a (kN/m)
0	0	0	0	0	0	333.63
5	100	0	100	30.70	19.62	
9	180	0	180	55.26	44.18	
10.5	207	0	207	63.55	63.55	

(b) Passive Earth Pressure Calculations

Depth (m)	σ_{ov} (kPa)	u_o (kPa)	σ'_{ov} (kPa)	σ'_{ph} (kPa)	σ_{ph} (kPa)	P_p (kN/m)
0	0	0	0	0	0	957.78
4	80	0	80	260.4	296.48	
5.5	107	0	107	348.29	348.29	

(c) Force Calculations

P_a (kN/m)	P_p (kN/m)	P_p/F (kN/m)	R (kN/m)
333.63	957.78	638.52	304.89

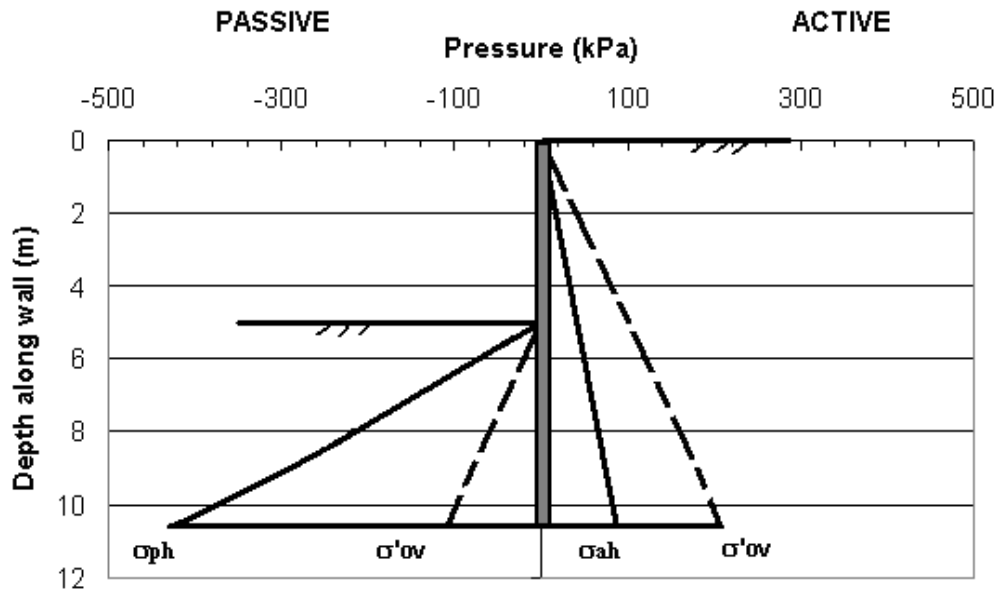

Figure 7 – 20. Active and Passive Earth Pressure Diagrams (Case 3a)

STEP 5b: Required Embedment Depth – The required embedment depth, D , is determined as described in section 6.6. The factor of safety against overturning, $F_{overturning}$, and the factor of safety against translation, $F_{translation}$, are determined using Equations 7 – 10 and 7 – 11. Trial and error allows for the embedment depth at $F_{overturning}=1.5$ to be determined. Table 7 – 13 compares the factors of safety for each trial embedment depth. Figure 7 – 21 shows the final dimensions of the cantilever wall for case 3a, a clay deposit over a uniform sand deposit without water.

Table 7 – 13. Factor of Safety Calculations (Case 3a)

Trail Embedment Depth, D	$FS_{overturning}$	$FS_{translation}$
6.50 m	1.82	3.33
6.00 m	1.69	3.11
5.80 m	1.62	3.01
5.50 m	1.50	2.87

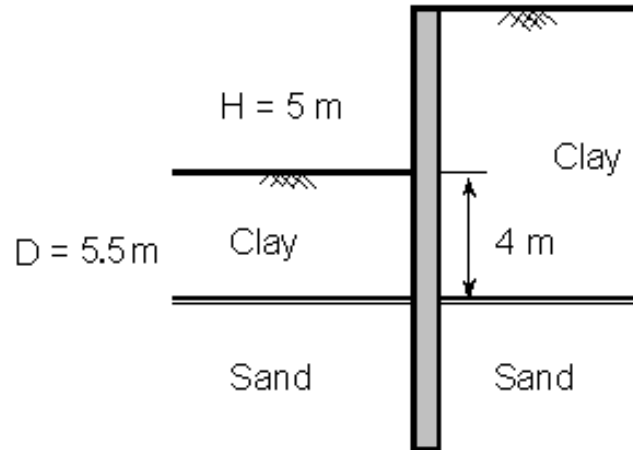

Figure 7 – 21. Final Dimension of Cantilever Wall (Case 3a)

STEP 5c: Maximum Bending Moment – The shear and bending moment diagrams are drawn to determine the maximum bending moment using traditional structural analysis.

STEP 6: Vertical Capacity of Wall – The downdrag on the wall is determined using procedures discussed in section 6.10 and is not illustrated here.

STEP 7: Structural Resistance of Retaining Elements – The failure of the columns in bending and shear must be checked as described in section 6.11.

STEP 8: Movements – Deflection based design will be illustrated for single tieback/support walls.

STEP 9: Other Considerations – See section 6.13 for additional considerations for design.

7.2.6 Cantilever Wall – Case 3b

This case will be used to illustrate the “plug” heave phenomenon that can occur when a deposit of clay is layered over a sand deposit (Figure 7 – 22) in a seepage condition as discussed in section 6.4.

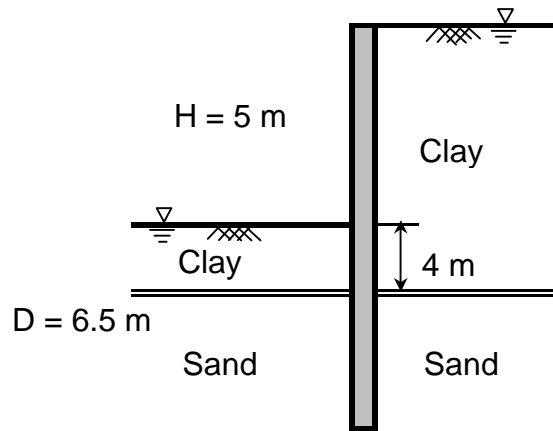

Figure 7 – 22. Cross Section of Cantilever with Soil Properties (Case 3b)

As defined in Equation 7 – 18 and illustrated in Figure 23, failure (heave) occurs when (neglecting friction between wall and plug)

$$u = \gamma_t H_c \text{ or } H_c = \frac{u}{\gamma_t} \quad (7 - 18)$$

where:

- u is the pore pressure at the bottom of the clay
- γ_t is the total unit weight of the soil,
- H_c is the height of the clay layer

Equation 7 – 19 must be ensured such that:

$$H_{c(\text{design})} = F H_{c(\text{failure})} \quad (7 - 19)$$

where:

- $H_{c(\text{design})}$ is the height of the clay layer for design
- $H_{c(\text{failure})}$ is the height of the clay layer at failure
- F is the chosen factor of safety

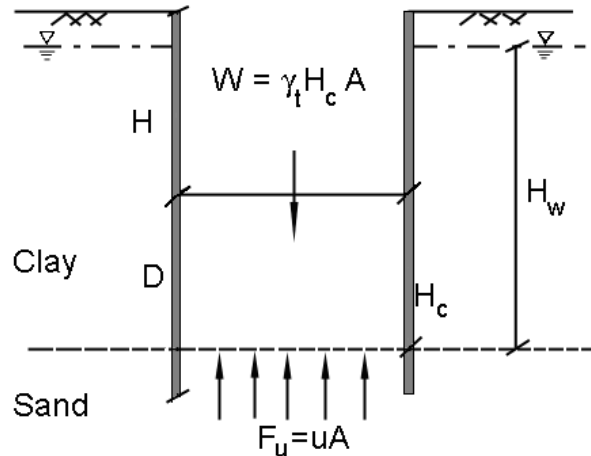

Figure 7 – 23. Plug Heave (Case 3b)

For this example:

width of the excavation, $w = 5 \text{ m}$

total unit weight of the clay, $\gamma_t = 20 \text{ kN/m}^3$

height of the clay, $H_c = 4 \text{ m}$

depth of the embedment, $D = 6.5 \text{ m}$

height of water, $H_w = 9 \text{ m}$

weight of plug, $W = \gamma_t H_c A = 20(\text{kN} / \text{m}^3) \times 4\text{m} \times 5\text{m} = 400 \text{ kN/m}$

uplift force, $F_u = uA$

where:

the pore pressure, u , is assumed to be $u = H_w \gamma_w = 9\text{m} \times 9.81 \frac{\text{kN}}{\text{m}^3} = 88.29 \frac{\text{kN}}{\text{m}^2}$

Therefore,

$$F_u = 88.29 \frac{\text{kN}}{\text{m}^2} \times 5\text{m} = 441.45 \text{ kN/m}$$

Plug heave failure is possible because $F_u > W$. A less conservative approach would include the clay-wall friction resistance. To decrease plug heave potential, the height of the water should be decreased through dewatering.

7.3 DESIGN EXAMPLE – SINGLE TIEBACK WALL AND MULTIPLE TIEBACK WALL

Because the method to design a single and multiple tieback wall are similar, only single tieback wall examples will be presented. The cases for the single support/tieback wall examples are summarized in Table 7 – 14. The first case illustrates the design of the wall in a uniform sand of infinite depth with the given soil parameters using various design methods. The second case illustrates the design of the wall in a uniform clay with the given soil parameters using various design methods.

Table 7 – 14. Single Support/Tieback Wall Design Example Cases

Cases	Soil	Soil Parameters
1a – Apparent Earth Pressure	Uniform sand infinite depth no water	$\gamma_t=18 \text{ kN/m}^3$; $\phi=32^\circ$
1b – Briaud and Lim (1999) method		
2a – Apparent Earth Pressure	uniform clay no water	$\gamma_t = 20 \text{ kN/m}^3$; $\phi = 32^\circ$; $c = 10 \text{ kPa}$
2b – Briaud and Lim (1999) method		

7.3.1 Single Anchor Wall - Case 1a. Apparent Earth Pressure Method

STEP 1: Site Investigation – Uniform sand infinite depth with no water.

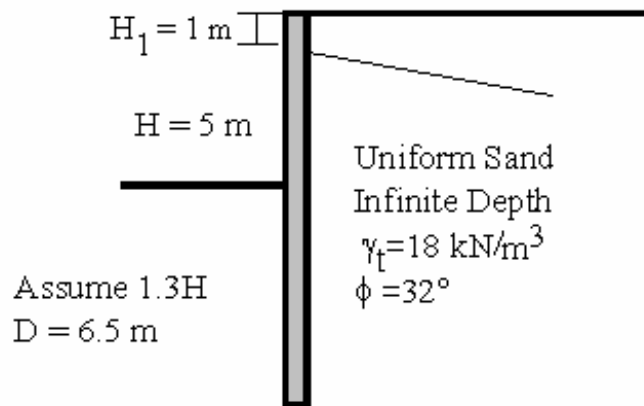

Figure 7 – 24. Cross Section of Single Anchor Wall with Soil Properties (Case 1a)

STEP 2: Project Parameters – The initial wall geometry is assumed base on project requirements. An initial estimate of the embedment depth, D , can be assumed as $D = 1.3H$ where H is the height of the excavation (Figure 7 – 24).

STEP 3: Seepage Analysis – A seepage analysis is not required because water is not present.

STEP 4: External Stability – Base stability analysis is determined using a circular slip failure analysis as shown in Figure 7 – 25.

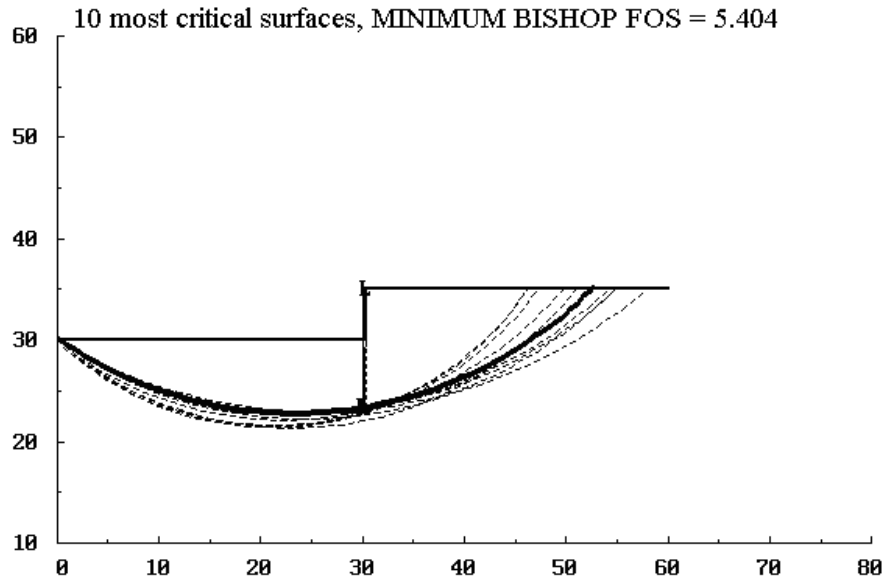

Figure 7 – 25. Base Stability for Single Anchor Wall (Case 1a)

STEP 5a: Earth Pressures – The apparent earth pressure for sand, σ_{apparent} , is calculated above the excavation base. Table 7 – 15 shows the apparent earth pressure with depth along the wall above the excavation base.

$$\sigma_{\text{apparent}}(z) = 0.65 K_a \sigma'_{ov} + \alpha u(z) \quad (7 - 20)$$

where

σ_{apparent} is the apparent total earth pressure

K_a is the coefficient of active earth pressure

σ'_{ov} is the effective vertical stress on the retained side at the excavation level

α is the ratio of water over total pore area (use 0 for unsaturated soils or soils in the capillary zone, and 1 for saturated soils under the GWT)

u is the water stress at depth z

Table 7 – 15. Apparent Earth Pressure for Single Support/Tieback Wall (Case 1a)

Depth (m)	σ_{apparent} (kPa)
0	17.96
5	17.96

The earth pressures below the excavation base are calculated per meter of wall using Equations 7 – 1 through 7 – 9. Table 7 – 16 shows the active and passive values determined after optimizing the embedment depth. Figure 7 – 24 illustrates the apparent, active, and passive earth pressures on the wall.

Table 7 – 16. Earth Pressure Calculations for Single Support/Tieback Wall (Case 1a)

(a) Active Earth Pressure Calculations

Depth (m)	σ_{ov} (kPa)	u_o (kPa)	σ'_{ov} (kPa)	σ'_{ah} (kPa)	σ_{ah} (kPa)	P_a (kN/m)
0	0	0	0	0	0	304.03
5	90	0	90	27.63	27.63	
10.54	189.72	0	189.72	57.69	57.69	

(b) Passive Earth Pressure Calculations

Depth (m)	σ_{ov} (kPa)	u_o (kPa)	σ'_{ov} (kPa)	σ'_{ph} (kPa)	σ_{ph} (kPa)	P_p (kN/m)
0	0	0	0	0	0	882.88
5.54	99.72	0	99.72	318.73	318.73	

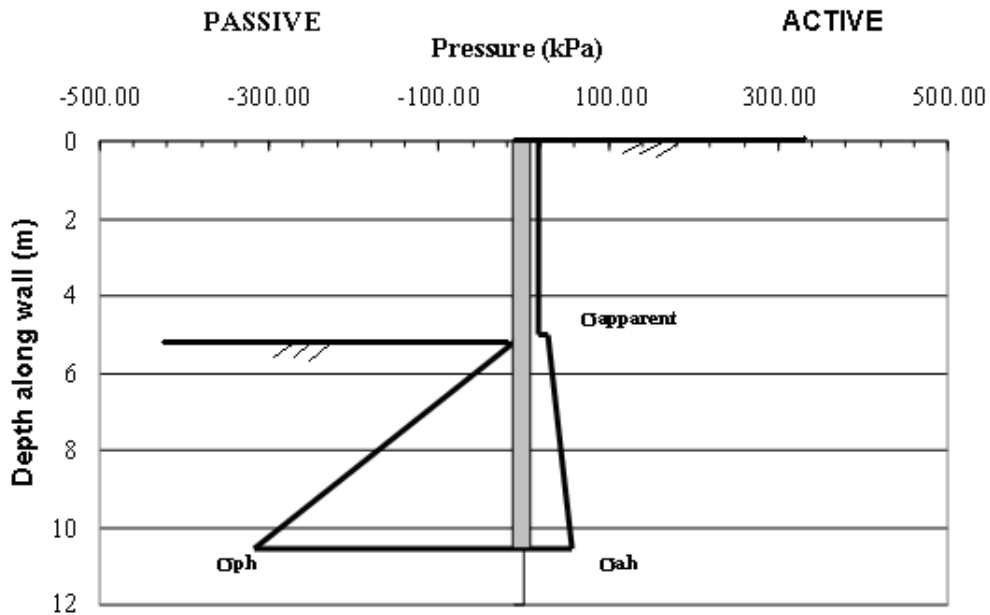

Figure 7 – 26. Earth Pressure Diagrams for Single Anchor Wall (Case 1a)

STEP 5b: Anchor Load - Anchor load determined by tributary area method (Figure 7 – 27). For this case, $T = 3m \times \sigma_{apparent} = 53.88 \text{ kN/m}$

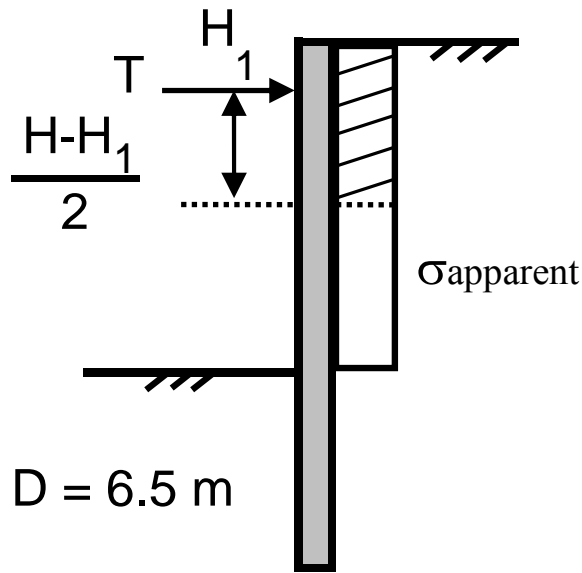

Figure 7 – 27. Tributary Area Method

STEP 5c: Required Embedment Depth - The embedment depth, D , is calculated by taking moment equilibrium at excavation base. Trial and error of embedment depth until desired factor of safety obtained. The kickback force, R , is calculated from horizontal equilibrium (Table 7 – 17).

Table 7 – 17. Factor of Safety and Force Calculations for Single/Tieback Wall (Case 1a)

Trail Embedment Depth, D	$FS_{\text{overturning}}$	Kickback Force, R (kN/m)
6.50 m	1.69	376.81
6.00 m	1.59	338.12
5.80 m	1.55	322.64
5.54 m	1.50	302.83

STEP 5d: Maximum Bending Moment – The shear and bending moment diagrams are drawn to determine the maximum bending moment using traditional structural analysis. It is difficult to determine bending moments by hand calculations in this complex case. Simplifications can be made to determine the bending moments as discussed in section 6.7.

STEP 5e: Optimize Tieback Location – The location of the anchor is moved along the wall to optimize the two calculated moments. It is important to remember that placing the tieback close to the top of the wall is one of the best ways to limit deflection at the top of the wall.

STEP 6: Vertical Capacity of Wall – The downdrag on the wall is determined using procedures discussed in section 6.10 and is not illustrated here.

STEP 7: Structural Resistance of Retaining Elements – The failure of the columns in bending and shear must be checked as described in section 6.11.

STEP 8: Movements – Deflection based design will be illustrated for single tieback/support walls in case 1b/c and case 2b/c.

STEP 9: Other Considerations – See section 6.13 for additional considerations for design.

7.3.2 Single Anchor Wall - Case 1b. Briaud and Lim (1999) Method

Movements of in situ walls systems are directly related to the stiffness of the system. This method will outline design procedures to choose the anchor loads to generate the approximate chosen deflection. Deformation control design is discussed in more detail in section 6.12.

STEP 1: Site Investigation – Uniform sand infinite depth with no water (Figure 7 – 28).

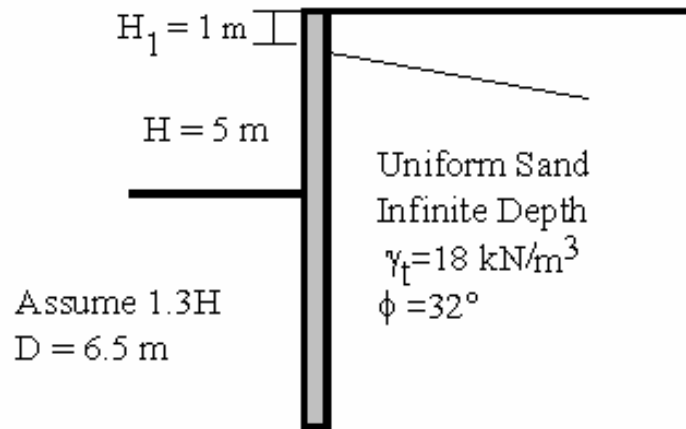

Figure 7 – 28. Cross Section of Single Anchor Wall with Soil Properties (Case 1b)

STEP 2: Project Parameters – The initial wall geometry is assumed base on project requirements. An initial estimate of the embedment depth, D , can be assumed as $D = 1.3H$ where H is the height of the excavation. The chosen maximum deflection for the top of the wall, u_{top} is .015 m.

STEP 3: Seepage Analysis – A seepage analysis is not required because water is not present.

STEP 4: External Stability – Base stability analysis is determined using a circular slip failure analysis as shown in Figure 7 – 29.

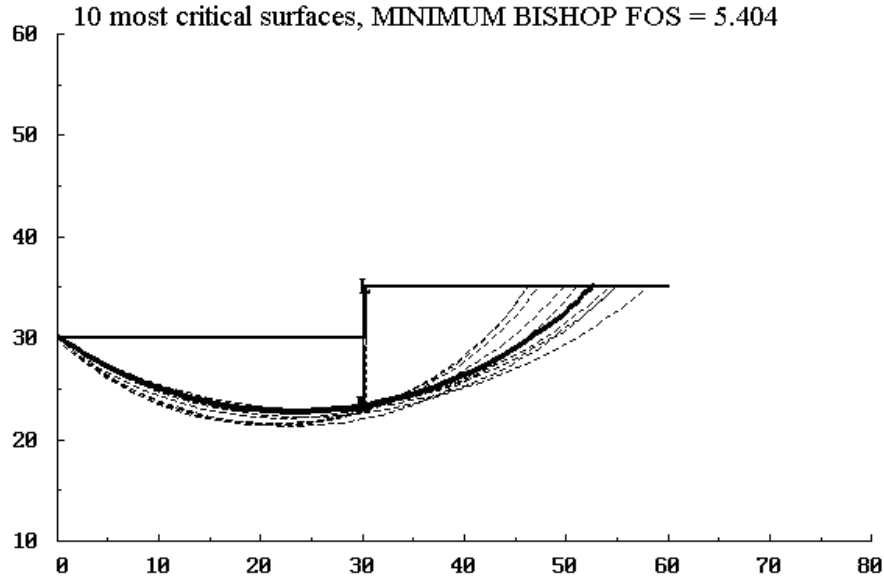

Figure 7 – 29. Base Stability for Single Anchor Wall (Case 1b)

STEP 5a: Earth Pressures – The maximum horizontal deflection of the top of the wall, $u_{top} = 0.015\text{m}$. Therefore $u_{top}/H = 0.015\text{m}/5\text{m} = .003$

The apparent total earth pressure or total horizontal pressure above the excavation, σ_h , is calculated using Equation 7 – 21.

$$\sigma_h = k \sigma'_{ov} + \alpha u \quad (7 - 21)$$

where:

σ_h is the constant total horizontal pressure above the excavation

k is the coefficient of apparent earth pressure (

Figure 6 – 13 or Figure 6 – 14)

σ'_{ov} is the effective vertical stress on the retained side at the excavation level

α is the ratio of water pore cross section area over the total pore cross section area. ($\alpha = 1$ for saturated soils under the GWT and $\alpha = 0$ for unsaturated soils or soils in the capillary zone)

u is the water stress (pore water pressure)

The earth pressure coefficient, k , is determined using

Figure 6 – 13. Earth Pressure Coefficient Versus Top Deflection, $k \approx 0.20$. The graph allow for the earth pressure coefficient to be determined using specified deflection criteria.

Table 7 – 18 shows the horizontal earth pressure with depth along the wall above the excavation base.

Table 7 – 18. Horizontal Earth Pressure for Single Anchor Wall (Case 1b)

Depth (m)	$\sigma_{\text{horizontal}}$ (kPa)
0	18.00
5	18.00

The active and passive earth pressures below the excavation are determined following the same procedures discussed for the cantilever wall. The earth pressures below the excavation base are calculated per meter of wall using Equations 7 – 1 through 7 – 9. Table 7 – 19 shows the active and passive values determined after optimizing the embedment depth. Figure 7 – 30 illustrates the horizontal, active, and passive earth pressures on the wall.

Table 7 – 19. Earth Pressure Calculations for Single Anchor Wall (Case 1b)

(a) Active Earth Pressure Calculations

Depth (m)	σ_{ov} (kPa)	u_0 (kPa)	σ'_{ov} (kPa)	σ'_{ah} (kPa)	σ_{ah} (kPa)	P_a (kN/m)
0	0	0	0	0	0	304.03
5	90	0	90	27.63	27.63	
10.54	189.72	0	189.72	57.69	57.69	

(b) Passive Earth Pressure Calculations

Depth (m)	σ_{ov} (kPa)	u_0 (kPa)	σ'_{ov} (kPa)	σ'_{ph} (kPa)	σ_{ph} (kPa)	P_p (kN/m)
0	0	0	0	0	0	882.88
5.54	99.72	0	99.72	318.73	318.73	

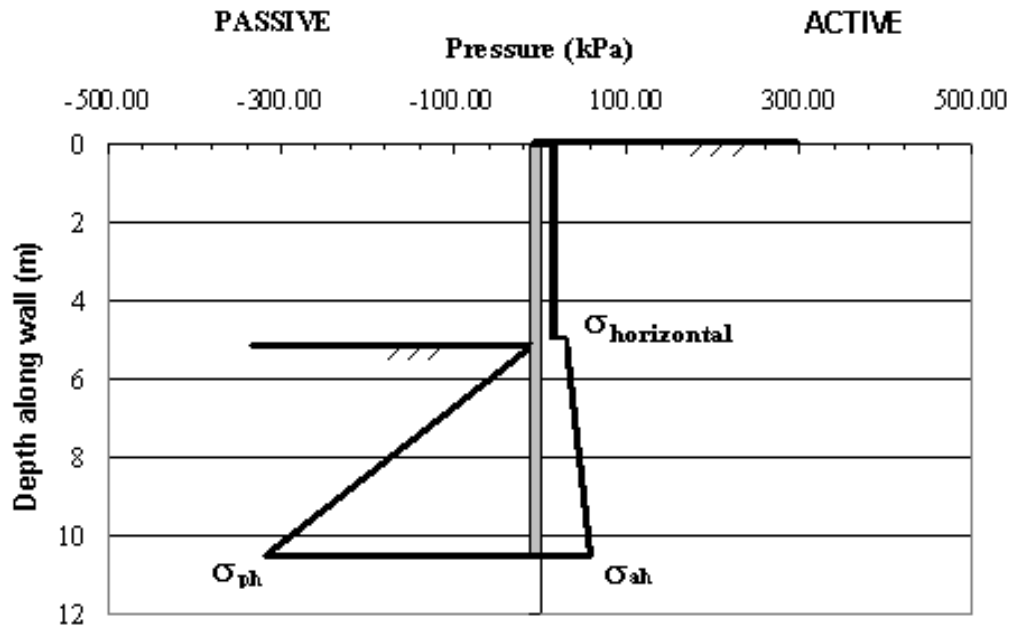

Figure 7 – 30. Earth Pressure Diagrams for Single Anchor Wall (Case 1b)

STEP 5b: Anchor Load - Anchor load determined by tributary area method. For this case,
 $T = 3m \times \sigma_{horizontal} = 54 \text{ kN/m}$

STEP 5c: Required Embedment Depth - The embedment depth, D , is calculated by taking moment equilibrium at excavation base. Trial and error of embedment depth until desired factor of safety obtained. The kickback force, R , is calculated from horizontal equilibrium (Table 7 – 20).

Table 7 – 20. Factor of Safety and Kickback Force Calculations for Single Support/Tieback Wall (Case 1b)

Trail Embedment Depth, D	$FS_{overturning}$	Kickback Force, R (kN/m)
6.50 m	1.69	376.81
6.00 m	1.59	338.12
5.80 m	1.55	322.64
5.54 m	1.50	302.83

STEP 5d: Maximum Bending Moment – The shear and bending moment diagrams are drawn to determine the maximum bending moment using traditional structural analysis. It is difficult to determine bending moments by hand calculations in this complex case. Simplifications can be made to determine the bending moments as discussed in section 6.7.

STEP 6: Vertical Capacity of Wall – The downdrag on the wall is determined using procedures discussed in section 6.10 and is not illustrated here.

STEP 7: Structural Resistance of Retaining Elements – The failure of the columns in bending and shear must be checked as described in section 6.11.

STEP 8: Movements – Deflection based design will be illustrated for single tieback/support walls.

STEP 9: Other Considerations – See section 6.13 for additional considerations for design.

7.3.3 Case 2a. Apparent Earth Pressure Method

STEP 1: Site Investigation – Uniform clay infinite depth with no water (Figure 7 – 31).

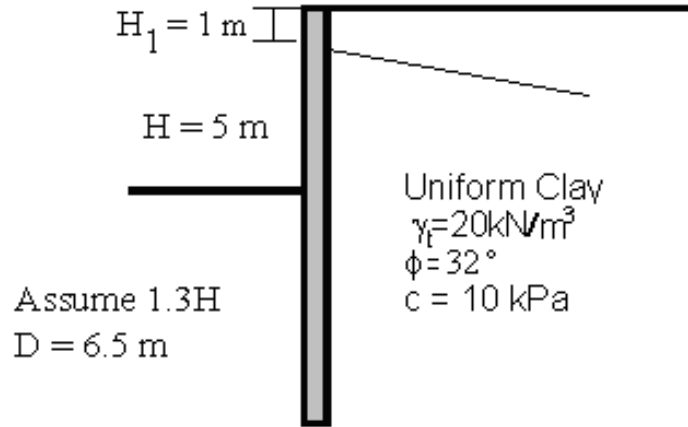

Figure 7 – 31. Cross Section of Single Anchor Wall with Soil Properties (Case 2a)

STEP 2: Project Parameters – The initial wall geometry is assumed base on project requirements. An initial estimate of the embedment depth, D , can be assumed as $D = 1.3H$ where H is the height of the excavation (Figure 7 – 31).

STEP 3: Seepage Analysis – A seepage analysis is not required because water is not present.

STEP 4: External Stability – Base stability analysis is determined using a circular slip failure analysis as shown in Figure 7 – 32.

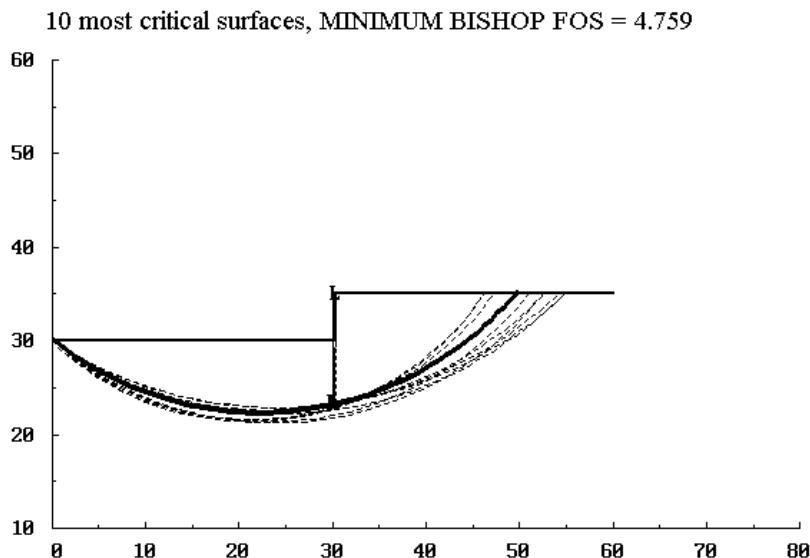

Figure 7 – 32. Base Stability for Single Anchor Wall (Case 2a)

STEP 5a: Earth Pressures – The apparent earth pressure for clay, σ_{apparent} , is calculated above the excavation base. Table 7 – 21 shows the apparent earth pressure with depth along the wall above the excavation base.

$$\sigma_{\text{apparent}}(z) = \beta \sigma'_{\text{ov}} + \alpha u(z) \quad (7 - 20)$$

where:

σ_{apparent} is the apparent total earth pressure

β varies between 0.2 to 0.4 (in this example, $\beta = 0.3$)

σ'_{ov} is the effective vertical stress on the retained side at the excavation level

α is the ratio of water over total pore area (use 0 for unsaturated soils or soils in the capillary zone, and 1 for saturated soils under the GWT)

u is the water stress at depth z

Table 7 – 21. Apparent Earth Pressure Calculations for Single Support/Tieback Wall (Case 2a)

Depth (m)	σ_{apparent} (kPa)
0	9.21
5	9.21

The earth pressures below the excavation base are calculated per meter of wall using Equations 7 – 1 through 7 – 9. Table 7 – 22 shows the active and passive values determined after optimizing the embedment depth. Figure 7 – 26 illustrates the apparent, active, and passive earth pressures on the wall.

Table 7 – 22. Earth Pressure Calculations for Single Support/Tieback Wall (Case 2a)

(a) Active Earth Pressure Calculations

Depth (m)	σ_{ov} (kPa)	u_0 (kPa)	σ'_{ov} (kPa)	σ'_{ah} (kPa)	σ_{ah} (kPa)	P_a (kN/m)
0	0	0	0	0	0	302.59
5	100	0	100	27.63	27.63	
10.49	209.8	0	209.8	57.69	57.69	

(b) Passive Earth Pressure Calculations

Depth (m)	σ_{ov} (kPa)	u_0 (kPa)	σ'_{ov} (kPa)	σ'_{ph} (kPa)	σ_{ph} (kPa)	P_p (kN/m)
0	0	0	0	0	0	874.91
5.49	109.8	0	109.8	318.73	318.73	

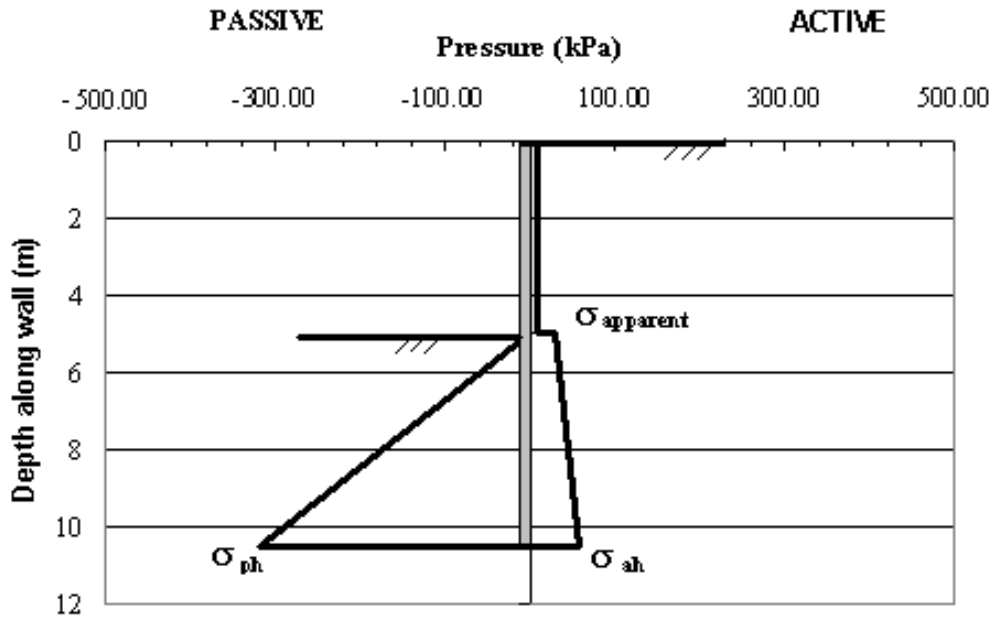

Figure 7 – 33. Earth Pressure Diagrams Single Anchor Wall (Case 2a)

STEP 5b: ANCHOR LOAD - Anchor load determined by tributary area. For this case,
 $T = 3m \times \sigma_{\text{apparent}} = 27.63 \text{ kN/m}$

STEP 5c: Required Embedment Depth - The embedment depth, D , is calculated by taking moment equilibrium at excavation base. Trial and error of embedment depth until desired factor of safety obtained. The kickback force, R , is calculated from horizontal equilibrium (Table 7 – 23).

Table 7 – 23. Factor of Safety and Kickback Force Calculations for Single Support/Tieback Wall (Case 2a)

Trail Embedment Depth, D	$FS_{\text{overturning}}$	Kickback Force, R (kN/m)
6.50 m	1.73	368.07
6.00 m	1.62	329.37
5.80 m	1.40	258.16
5.49 m	1.50	292.99

STEP 5d: Maximum Bending Moment – The shear and bending moment diagrams are drawn to determine the maximum bending moment using traditional structural analysis. It is difficult to determine bending moments by hand calculations in this complex case. Simplifications can be made to determine the bending moments as discussed in section 6.7.

STEP 6: Vertical Capacity of Wall – The downdrag on the wall is determined using procedures discussed in section 6.10 and is not illustrated here.

STEP 7: Structural Resistance of Retaining Elements – The failure of the columns in bending and shear must be checked as described in section 6.11.

STEP 8: Movements – Deflection based design will be illustrated in cases 1b/c and 2b/c.

STEP 9: Other Considerations – See section 6.13 for additional considerations for design.

7.3.4 Single Anchor Wall - Case 2b. Briaud and Lim (1999) Method

Movements of in situ walls systems are directly related to the stiffness of the system. This method will outline design procedures to choose the anchor loads to generate the approximate chosen deflection. Deformation control design is discussed in more detail in section 6.12.

STEP 1: Site Investigation – Uniform clay infinite depth with no water.

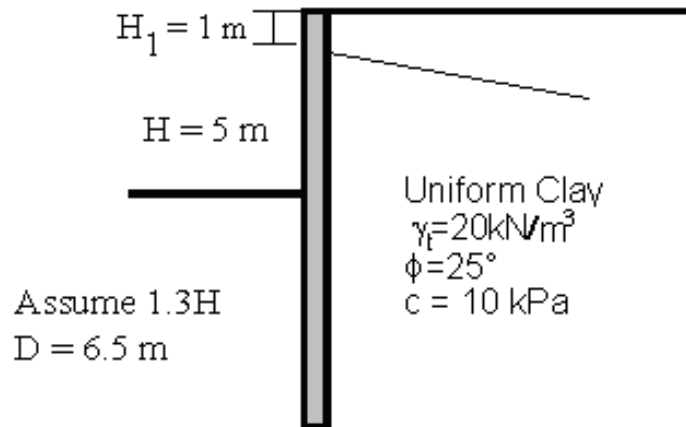

Figure 7 – 34. Cross Section of Single Anchor Wall with Soil Properties (Case 1b)

STEP 2: Project Parameters – The initial wall geometry is assumed based on project requirements. An initial estimate of the embedment depth, D , can be assumed as $D = 1.3H$ where H is the height of the excavation (Figure 7 – 31). The chosen maximum deflection for the top of the wall, u_{top} is .015 m.

STEP 3: Seepage Analysis – A seepage analysis is not required because water is not present.

STEP 4: External Stability – Base stability analysis is determined using a circular slip failure analysis as shown in Figure 7 – 32.

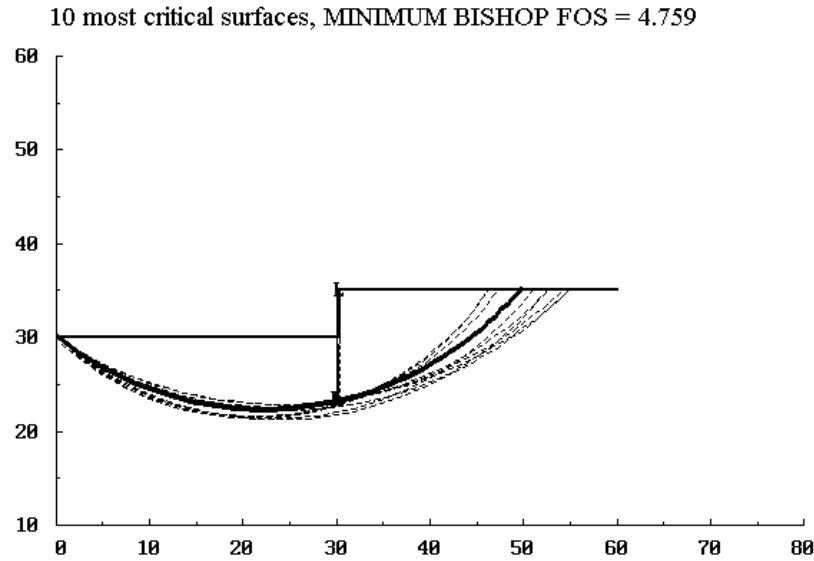

Figure 7 – 35. Base Stability for Single Anchor Wall (Case 2b)

STEP 5a: Earth Pressures – The maximum horizontal deflection of the top of the wall, $u_{top} = 0.015\text{m}$. Therefore $u_{top}/H = 0.015\text{m}/5\text{m} = .003$

The apparent total earth pressure or total horizontal pressure above the excavation, σ_h , is calculated using Equation 7 – 21.

$$\sigma_h = k \sigma'_{ov} + \alpha u \quad (7 - 21)$$

where:

σ_h is the constant total horizontal pressure above the excavation

k is the coefficient of apparent earth pressure (

Figure 6 – 13 or Figure 6 – 14)

σ'_{ov} is the effective vertical stress on the retained side at the excavation level.

α is the ratio of water pore cross section area over the total pore cross section area. ($\alpha = 1$ for saturated soils under the GWT and $\alpha = 0$ for unsaturated soils or soils in the capillary zone)

u is the water stress (pore water pressure)

The earth pressure coefficient, k , is determined using

Figure 6 – 13. Earth Pressure Coefficient Versus Top Deflection, $k \approx 0.20$. The graph allow for the earth pressure coefficient to be determined using specified deflection criteria.

Table 7 – 18 shows the horizontal earth pressure with depth along the wall above the excavation base.

Table 7 – 24. Horizontal Earth Pressure for Single Anchor Wall (Case 2b)

Depth (m)	$\sigma_{\text{horizontal}}$ (kPa)
0	20.00
5	20.00

The active and passive earth pressures below the excavation are determined following the same procedures discussed for the cantilever wall. The earth pressures below the excavation base are calculated per meter of wall using Equations 7 – 1 through 7 – 9. Table 7 – 19 shows the active and passive values determined after optimizing the embedment depth. Figure 7 – 30 illustrates the horizontal, active, and passive earth pressures on the wall.

Table 7 – 25. Earth Pressure Calculations for Single Anchor Wall (Case 2b)

(a) Active Earth Pressure Calculations

Depth (m)	σ_{ov} (kPa)	u_0 (kPa)	σ'_{ov} (kPa)	σ'_{ah} (kPa)	σ_{ah} (kPa)	P_a (kN/m)
0	0	0	0	0	0	304.03
5	100	0	100	27.63	27.63	
10.54	210.8	0	210.8	57.69	57.69	

(b) Passive Earth Pressure Calculations

Depth (m)	σ_{ov} (kPa)	u_0 (kPa)	σ'_{ov} (kPa)	σ'_{ph} (kPa)	σ_{ph} (kPa)	P_p (kN/m)
0	0	0	0	0	0	882.88
5.54	110.8	0	110.8	318.73	318.73	

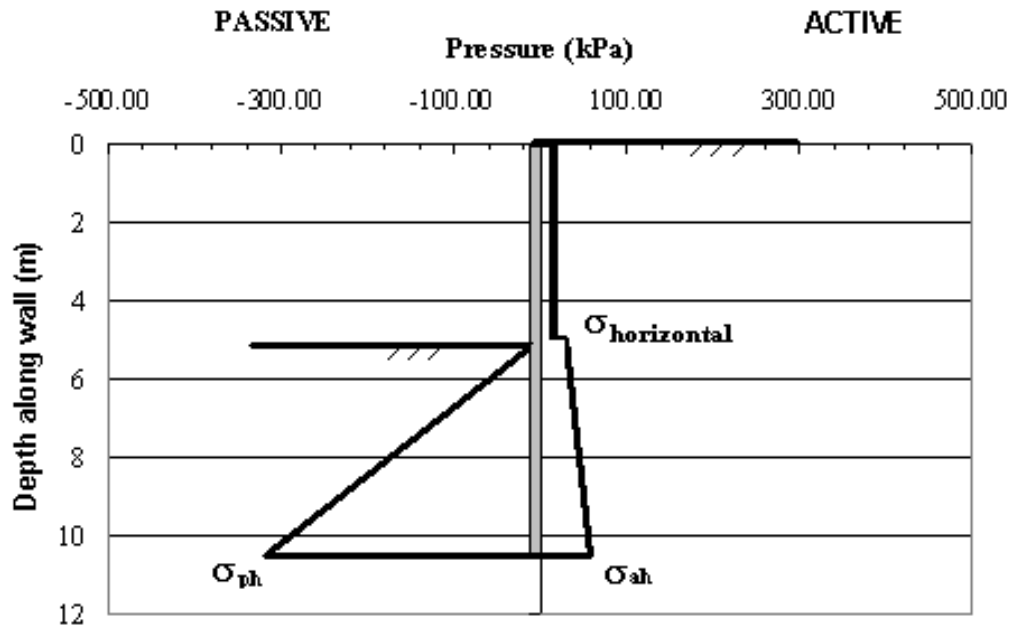

Figure 7 – 36. Earth Pressure Diagrams on Single Anchor Wall (Case 2b)

STEP 5b: Anchor Load - Anchor load determined by tributary area method. For this case,
 $T = 3m \times \sigma_{\text{apparent}} = 60 \text{ kN/m}$

STEP 5c: Required Embedment Depth - The embedment depth, D, is calculated by taking moment equilibrium at excavation base. Trial and error of embedment depth until desired factor of safety obtained. The kickback force, R, is calculated from horizontal equilibrium (Table 7 – 26).

Table 7 – 26. Factor of Safety and Kickback Force Calculations for Single Support/Tieback Wall (Case 2b)

Trail Embedment Depth, D	FS _{overturning}	Kickback Force, R (kN/m)
6.50 m	1.69	378.86
6.00 m	1.59	340.16
5.80 m	1.56	324.68
5.49 m	1.50	304.55

STEP 5d: Maximum Bending Moment – The shear and bending moment diagrams are drawn to determine the maximum bending moment using traditional structural analysis. It is difficult to determine bending moments by hand calculations in this complex case. Simplifications can be made to determine the bending moments as discussed in section 6.7.

STEP 6: Vertical Capacity of Wall – The downdrag on the wall is determined using procedures discussed in section 6.10 and is not illustrated here.

STEP 7: Structural Resistance of Retaining Elements – The failure of the columns in bending and shear must be checked as described in section 6.11.

STEP 8: Movements – Deflection based design will be illustrated for single tieback/support walls.

STEP 9: Other Considerations – See section 6.13 for additional considerations for design.

7.4 PROJECT DESIGN EXAMPLE 1 – BASED ON LAKE PARKWAY PROJECT, MILWAUKEE, WI

The Lake Parkway project in Milwaukee, Wisconsin required the construction of a depressed roadway located in a railway/utility corridor of a residential area. The roadway was 912 m (29.5 ft) long and in some areas as much as 9 m (29.5 ft) below grade. The alignment extended a distance of approximately 4.8 km (2.98 miles) from Interstate Highway 794 to E. Layton Ave. along north side of General Mitchell International Airport. Sheet pile walls were determined to be unacceptable due to the potential for leakage through joints. Three different retaining walls (cantilever, single tiered and double tiered) were designed for three separate sections of the project. This project design example will focus on the two tier anchored section designed as shown in Figure 7 – 37.

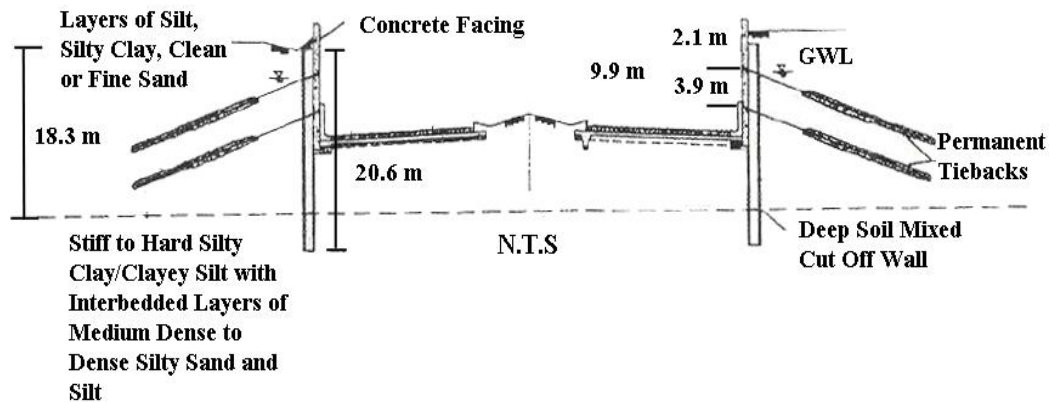

Figure 7 – 37. Cross Section of Lake Parkway Two Tier Anchor Wall (Design Example 1)

STEP 1: Site Investigation - The site is underlain by layers of silt, silty clay, and clean fine sands to depths of 4.6 m to 18.3 m (15.1 to 60 ft) below existing grade. Stiff to hard silty clay/clayey silt with interbedded layers of medium dense to dense silty sand and silt underlie the upper layers. The ground water is typically at a depth of 2.4 m (7.87 ft) below the ground surface. For implementation of the hand design method, the soil profile is simplified to a uniform clay deposit with no water. The total unit weight of the clay is 20.7 kN/m^3 with undrained shear strength of 72 kPa.

STEP 2: Project Parameters – The wall geometry is based on project requirements. The temporary excavation depth, H_{TEMP} , is 9.9 m for the two tier section of the retaining wall. An initial estimate of the embedment depth, D , can be assumed $D = 10.7 \text{ m}$ (Figure 7 – 38).

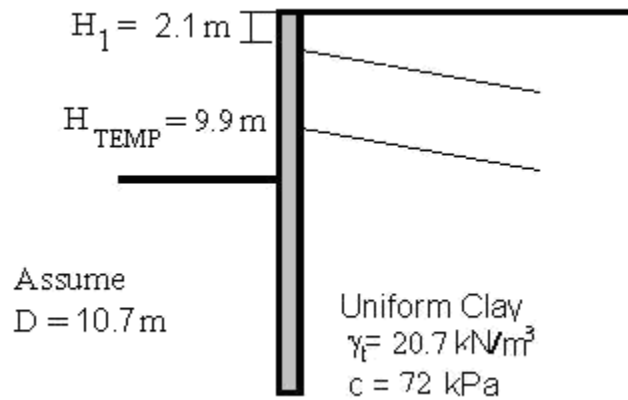

Figure 7 – 38. Cross Section of Two Tier Wall (Design Example 1)

STEP 3: Seepage Analysis – A seepage analysis is not required because water is assumed not to be present for simplification.

STEP 4: External Stability – Base stability analysis can be determined using a circular slip failure analysis.

STEP 5a: Earth Pressures – The apparent earth pressure for clay, $\sigma_{apparent}$, is calculated above the excavation base. Table 7 – 27 shows the apparent earth pressure with depth along the wall above the excavation base.

$$\sigma_{apparent}(z) = \beta \sigma'_{ov} + \alpha u(z) \quad (7 - 20)$$

where:

$\sigma_{apparent}$ is the apparent total earth pressure

β varies between 0.2 to 0.4 (in this example, $\beta = 0.3$)

σ'_{ov} is the effective vertical stress on the retained side at the excavation level

α is the ratio of water over total pore area (use 0 for unsaturated soils or soils in the capillary zone, and 1 for saturated soils under the GWT)

u is the water stress at depth z

Table 7 – 27. Apparent Earth Pressure for Two Tier Wall (Design Example 1)

Depth (m)	$\sigma_{apparent}$ (kPa)
0	61.48
9.9	61.48

The earth pressures below the excavation base are calculated per meter of wall using Equations 7 – 1 through 7 – 9. Table 7 – 28 shows the active and passive values determined after optimizing

the embedment depth. Figure 7 – 39 illustrates the apparent, active, and passive earth pressures on the wall.

Table 7 – 28. Earth Pressure Calculations for Two Tier Wall (Design Example 1)

(a) Active Earth Pressure Calculations

Depth (m)	σ_{ov} (kPa)	u_o (kPa)	σ'_{ov} (kPa)	σ'_{ah} (kPa)	σ_{ah} (kPa)	Pa (kN/m)
0	0	0	0	0	0	526.58
9.9	204.93	0	204.93	62.91	0	
20.6	426.42	0	426.42	130.91	51.12	

(b) Passive Earth Pressure Calculations

Depth (m)	σ_{ov} (kPa)	u_o (kPa)	σ'_{ov} (kPa)	σ'_{ph} (kPa)	σ_{ph} (kPa)	Pp (kN/m)
0	0	0	0	0	259.88	5249.81
5	103.5	0	103.5	337.10	596.98	
10.7	221.49	0	221.49	721.39	981.27	

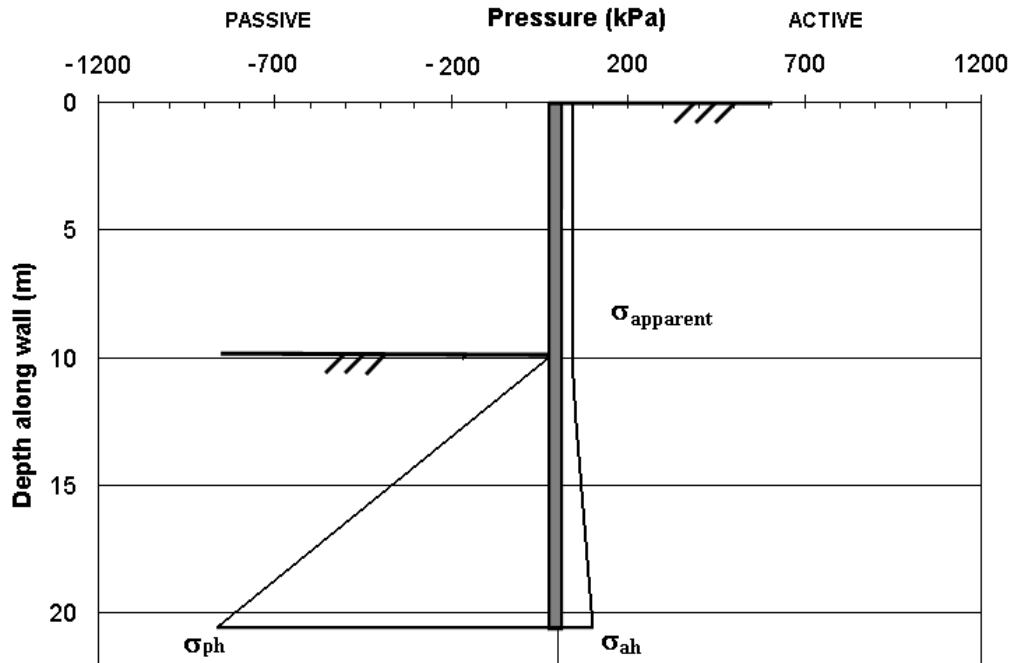

Figure 7 – 39. Earth Pressure Diagrams for Two Tier Wall (Design Example 1)

STEP 5b: Anchor Load – Anchor loads are determined by tributary area. For this case, the anchor loads are determined assuming anchor locations of $H_1=2.1$ m and $H_2 = 6.0$ m. $T_1 = 61.48$ kPa x (2.1 m +1.95 m) = 248.99 kN/m and $T_2 = 61.48$ kPa x (3.9 m) = 239.77 kN/m.

STEP 5c: Required Embedment Depth – The embedment depth, D , is calculated by taking moment equilibrium at excavation base. Trial and error of embedment depth until desired factor of safety obtained. The kickback force, R , is calculated from horizontal equilibrium. Table 7 – 29 shows the factor of safety and kickback force at the trial embedment depth of 10.7 m.

Table 7 – 29. Factor of Safety and Kickback Force Calculations for Two Tier Wall (Design Example 1)

Trial Embedment Depth, D	F_soverturning	Kickback Force, R (kN/m)
10.7 m	0.9597	3846.34

STEP 5d: Maximum Bending Moment – The shear and bending moment diagrams are drawn to determine the maximum bending moment using traditional structural analysis. It is difficult to determine bending moments by hand calculations in this complex case. Simplifications can be made to determine the bending moments as discussed in section 6.7. To continue the design example, a W610x125 wide flange beam will be chosen as reinforcement. The properties of the wide flange are shown in Table 7 – 30.

Table 7 – 30. Wide Flange Properties (Design Example 1)

Wide Flanges		Dimensions				Area	Weight
SI Designation	US Designation	d	b _f	t _w	t _f	mm ²	kg
		mm					
W610x125.0	W24x84	612	229	11.9	19.6	160.1	125.0

STEP 5e: Optimize Tieback Location – The locations of the anchors are moved along the wall to optimize the moments. It is important to remember that placing the upper tieback close to the top of the wall is one of the best ways to limit deflection at the top of the wall. The anchors are location at 2.1 m and 3.9 m, respectively. The tieback spacing is 2.1 m.

STEP 6: Vertical Capacity of Wall – The downdrag on the wall is determined using procedures discussed in section 6.10 and is not illustrated here.

STEP 7: Structural Resistance of Retaining Elements – The failure of the columns in bending and shear must be checked. Assuming a typical deep soil mix column arrangement with wide flanges at a spacing of 1.22 m (4 ft) center to center, the bending and shear failure are checked using the Taki and Yang (1991) procedure (Figure 7 – 40 and Figure 7 – 41).

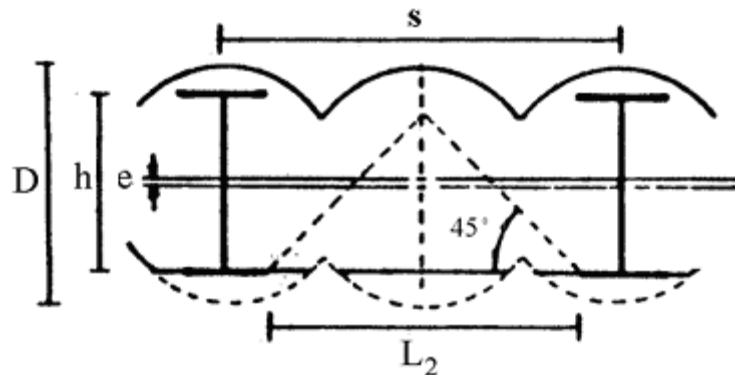

If $L_2 < D + h - 2e$, no bending failure

Assume W60x125 (W24x84) steel reinforcement and $e = 0$.

Beam spacing, $s = 48"$

Diameter, $D = 36"$

Height of beam, $h = 24.09"$

Width of beam, $b = 9.01"$

$L = s - b = 48" - 9.01" = 38.99"$

$D + h - 2e = 36" + 24.09" = 60.09"$

$38.99" < 60.09"$ therefore no bending failure.

Figure 7 – 40. Bending Failure Check for Two Tier Wall (Design Example 1)

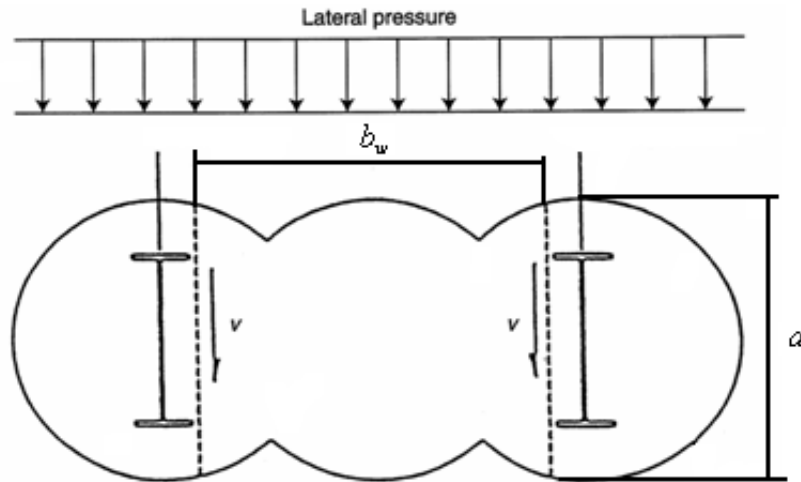

Using American Concrete Institute (ACI) equation 11.3 for nominal shear strength:

$$V_c = \lambda 2\sqrt{f'_c} b_w d$$

where λ for lightweight concrete is estimated as 0.75

f'_c for soil cement is assumed to be 2,000 kPa = 290.075 psi

b_w is the width of the block

d is the height of the block

Therefore,

$$V_c = 0.75 \sqrt{290.075 \text{ psi}} (38.99") (36")$$

$$V_c = 35,859.33 \text{ lb} = 159.51 \text{ kN}$$

$$V_{\text{max}} < V_c = 159.51 \text{ kN}$$

Figure 7 – 41. Shear Failure Check for Two Tier Wall (Design Example 1)

STEP 8: Movements – Deflection based design methods are discussed in section 6.12.

STEP 9: Other Considerations – Additional considerations for this project include exposure to repeated freezing and thawing conditions. Possible deterioration can be treated with shotcrete as replacement cover.

7.5 PROJECT DESIGN EXAMPLE 2 – BASED ON ISLAIS CREEK TRANSPORT/STORAGE SAN FRANCISCO, CA

The Islais Creek Transport/Storage Project in San Francisco, California included the construction of approximately 500 m (152.4 ft) of box sewer along Army, Indiana and Tulare Streets. A portion of the box sewer also serves as a controlled overflow structure in the event that the storage capacity of the system was exceeded. Construction of the sewer and overflow structure required 12 m (3.7 ft) deep excavations in relatively soft soil with a high groundwater table. A key issue for the excavation was the stability and deformations associated with the excavations particularly along the overflow structure where weak subsurface soils extended to depths of up to 33 m (10 ft). For the shoring system along Army (Cesar Chavez) Street, deep mixing was selected to construct a diaphragm wall system with steel soldier piles spaced at 1.3 m (0.4 ft). Three levels of internal struts were used to brace the excavation walls.

STEP 1: Site Investigation - The site is underlain by layers of fill, bay mud, and marine sand. The fill, ranging in thickness from 3.96 to 7.6 m (13 to 25 ft), consists of predominately loose to medium dense gravelly sand to sandy gravel with silt, clay, cobbles and other debris. Below the fill is a layer of dark gray, soft to medium stiff, plastic clay known locally as Bay Mud approximately 5.5 to 10.7 m (18 to 35 ft) thick. Beneath the Bay Mud is a layer of loose to medium dense, dark gray fine Marine sand with stringers of soft Bay Mud approximately 2.1 to 3.7 m (7 to 12 ft) thick. Weathered rock and bedrock are located below the fill, sand and Bay Mud. For implementation of the hand design method, the soil profile is simplified to a uniform clay deposit with no water. The total unit weight of the assumed clay layer is 15 kN/m^3 with shear strength of 17 kN/m^2 . The groundwater varies from depths of 1.8 to 2.7 m (6 to 9 ft) below the surface.

STEP 2: Project Parameters – The wall geometry is based on project requirements. The temporary excavation depth, H_{TEMP} , is 11.7 m (38.5 ft) for the Amy (Cesar Chavez) section of the project. An initial estimate of the embedment depth, D , can be assumed $D = 6.6 \text{ m}$ (21.5 ft) (Figure 7 – 42).

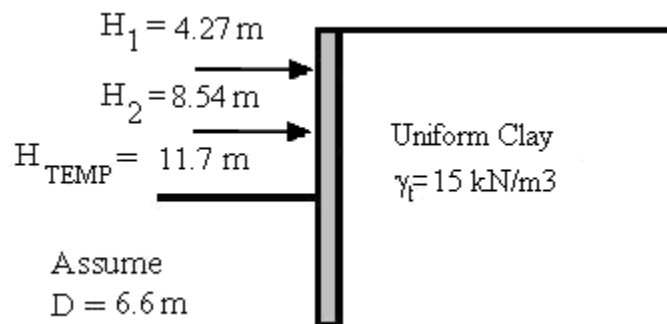

Figure 7 – 42. Cross Section of Army (Cesar Chavez) Street Shoring System (Design Example 2)

STEP 3: Seepage Analysis – A seepage analysis is not required because water is assumed not to be present for simplification.

STEP 4: External Stability – Base stability analysis can be determined using a circular slip failure analysis.

STEP 5a: Earth Pressures – The apparent earth pressure for clay, $\sigma_{apparent}$, is calculated above the excavation base. Table 7 – 31 shows the apparent earth pressure with depth along the wall above the excavation base.

$$\sigma_{apparent}(z) = \beta \sigma'_{ov} + \alpha u(z) \quad (7 - 20)$$

where:

$\sigma_{apparent}$ is the apparent total earth pressure

β varies between 0.2 to 0.4 (in this example, $\beta = 0.3$)

σ'_{ov} is the effective vertical stress on the retained side at the excavation level

α is the ratio of water over total pore area (use 0 for unsaturated soils or soils in the capillary zone, and 1 for saturated soils under the GWT)

u is the water stress at depth z

Table 7 – 31. Apparent Earth Pressure for Army (Cesar Chavez) Street Shoring System (Design Example 2)

Depth (m)	$\sigma_{apparent}$ (kPa)
0	52.65
11.7	52.65

The earth pressures below the excavation base are calculated per meter of wall using Equations 7 – 1 through 7 – 9. Table 7 – 32 shows the active and passive values determined after optimizing the embedment depth. Figure 7 – 43 illustrates the apparent, active, and passive earth pressures on the wall.

Table 7 – 32. Earth Pressure Calculations for Army (Cesar Chavez) Street Shoring System (Design Example 2)

(a) Active Earth Pressure Calculations

Depth (m)	σ_{ov} (kPa)	u_o (kPa)	σ'_{ov} (kPa)	σ'_{ah} (kPa)	σ_{ah} (kPa)	Pa (kN/m)
0	0	0	0	0	0	598.71
11.7	175.5	0	175.5	53.88	35.04	
18.3	274.5	0	274.5	84.27	65.43	

(b) Passive Earth Pressure Calculations

Depth (m)	σ_{ov} (kPa)	u_o (kPa)	σ'_{ov} (kPa)	σ'_{ph} (kPa)	σ_{ph} (kPa)	Pp (kN/m)
0	0	0	0	0	61.36	1266.55
3	45	0	45	146.57	207.93	
6.6	99	0	99	322.44	383.80	

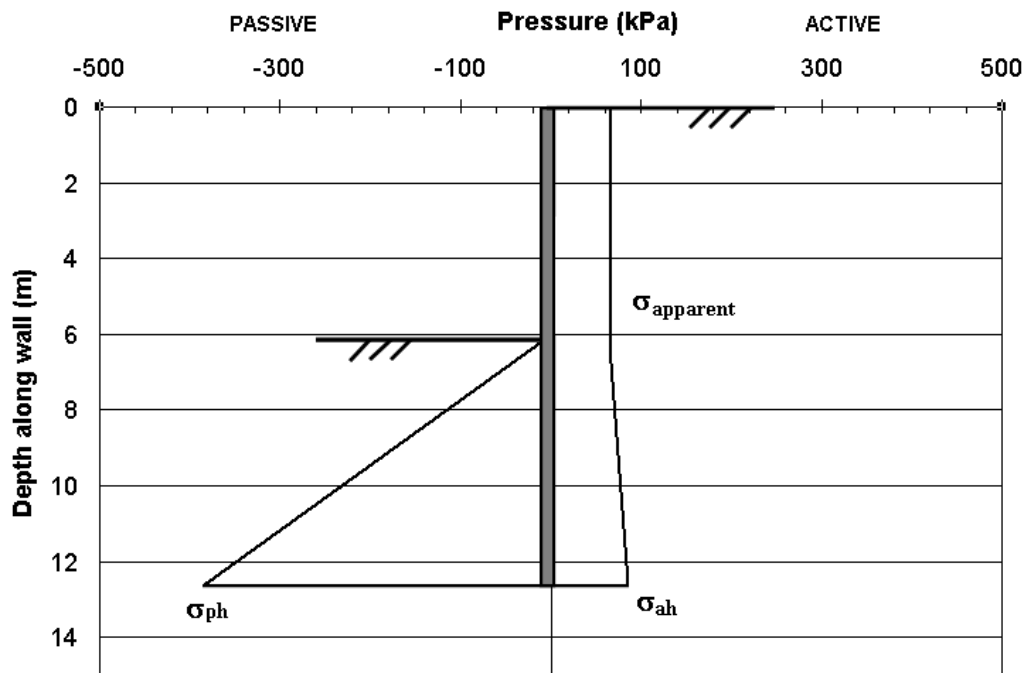

Figure 7 – 43. Earth Pressure Diagrams for Army (Cesar Chavez) Street Shoring System (Design Example 2)

STEP 5b: Strut Load - Strut loads are determined by tributary area. For this case, the strut loads are determined assuming locations of $H_1 = 4.27$ m and $H_2 = 8.54$ m. $T_1 = 52.65$ kPa \times (4.27 m + 2.14 m) = 337.49 kN/m and $T_2 = 52.65$ kPa \times (2.14 m + 1.58 m) = 195.86 kN/m.

STEP 5c: Required Embedment Depth – The embedment depth, D , is calculated by taking moment equilibrium at excavation base. Trial and error of embedment depth until desired factor of safety obtained. The kickback force, R , is calculated from horizontal equilibrium Table 7 – 33 shows the factor of safety and kickback force at the trial embedment depth of 6.6 m.

Table 7 – 33. Factor of Safety and Kickback Force Calculations for Army (Cesar Chavez) Street Shoring System (Design Example 2)

Trial Embedment Depth, D	Fsoverturning	Kickback Force, R (kN/m)
6.6 m	1.19	382.96

STEP 5d: Maximum Bending Moment – The shear and bending moment diagrams are drawn to determine the maximum bending moment using traditional structural analysis. It is difficult to determine bending moments by hand calculations in this complex case. Simplifications can be made to determine the bending moments as discussed in section 6.7. To continue the design example, a W30x108 wide flange beam will be chosen as reinforcement. The properties of the wide flange are shown in Table 7 – 34.

Table 7 – 34. Wide Flange Properties (Design Example 2)

Wide Flanges		Dimensions				Area	Weight
SI Designation	US Designation	d	b _f	t _w	t _f	mm ²	kg
		mm					
W762x161	W30x108	685.8	265.94	13.72	19.3	170.1	160.4

STEP 5e: Optimize Strut Location – The locations of the struts are moved along the wall to optimize the moments. The struts are location at 4.27m and 8.54 m, respectively. The strut spacing is 4.27 m.

STEP 6: Vertical Capacity of Wall – The downdrag on the wall is determined using procedures discussed in section 6.10 and is not illustrated here.

STEP 7: Structural Resistance of Retaining Elements – The failure of the columns in bending and shear must be checked. Assuming a typical deep soil mix column arrangement with wide flanges at a spacing of 1.22 m (4 ft) center to center, the bending and shear failure are checked using the Taki and Yang (1991) procedure (Figure 7 – 44 and Figure 7 – 45).

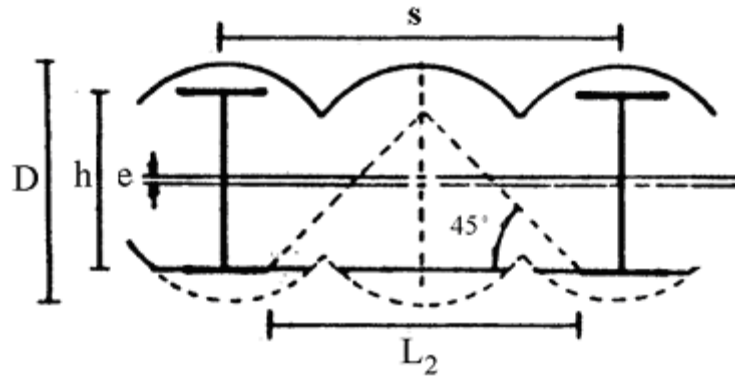

If $L_2 < D + h - 2e$, no bending failure

Assume W 762 x 161 steel reinforcement and $e = 0$.

Beam spacing, $s = 48"$

Diameter, $D = 36"$

Height of beam, $h = 29.84"$

Width of beam, $b = 10.47"$

$L = s - b = 48" - 10.47" = 37.53"$

$D + h - 2e = 36" + 29.84" = 65.84"$

$65.84" > 37.53"$ therefore no bending failure.

Figure 7 – 44. Bending Failure Check for Army (Cesar Chavez) Street Shoring System (Design Example 2)

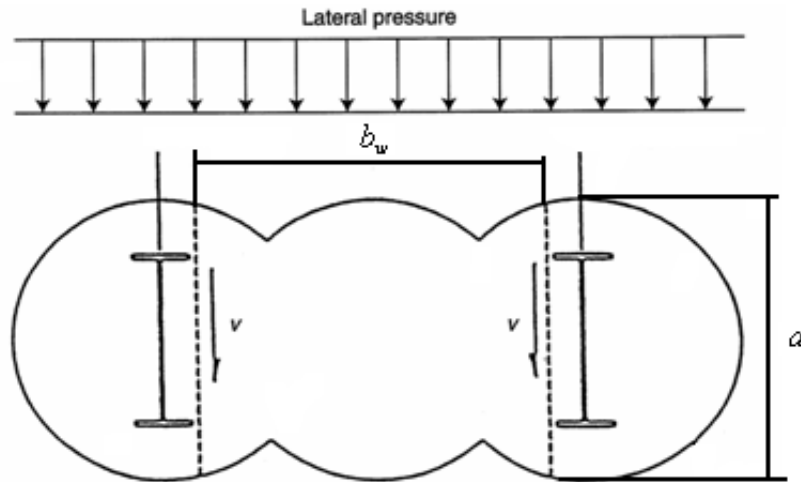

Using American Concrete Institute (ACI) equation 11.3 for nominal shear strength:

$$V_c = \lambda 2 \sqrt{f'_c} b_w d$$

where λ for lightweight concrete is estimated as 0.75

f'_c for soil cement is assumed to be 2,000 kPa = 290.075 psi

b_w is the width of the block

d is the height of the block

Therefore,

$$V_c = 0.75 \sqrt{290.075 \text{ psi}} (38.99") (36")$$

$$V_c = 35,859.33 \text{ lb} = 159.51 \text{ kN}$$

$$V_{\text{max}} < V_c = 159.51 \text{ kN}$$

Figure 7 – 45. Shear Failure Check for Army (Cesar Chavez) Street Shoring System (Design Example 2)

STEP 8: Movements – Deflection based design methods are discussed in section 6.12.

STEP 9: Other Considerations – Additional considerations for this project included the resistance of the hydrostatic pressures in the Marine Sand layer below the Bay Mud. Relief wells were installed to reduce hydrostatic levels in the excavation.

CHAPTER 8

CONSTRUCTION

8.1 INTRODUCTION

Construction techniques, as well as water–cement ratios and soil cement ratios, depend largely on the contractor working on the project. Successful deep mixed walls are dependent upon a combination of geology, equipment, mix design, and installation operation including drill technique and quality control (Taki and Yang, 1991). The experience and expertise of the project contractors also play an importation factor in the quality of the resulting soil cement walls (Porbaha et al., 2001). The operations are broken into two main categories: (1) slurry production, and (2) control of soil mixing machinery, as illustrated in Figure 8 – 1. Slurry production comprises of the creation of the slurry by weighing, mixing and agitating the mixture in the batch mixing plant. The second operation is the control of the machinery in which both the rate of slurry injection and actual mixing and drilling augers are controlled.

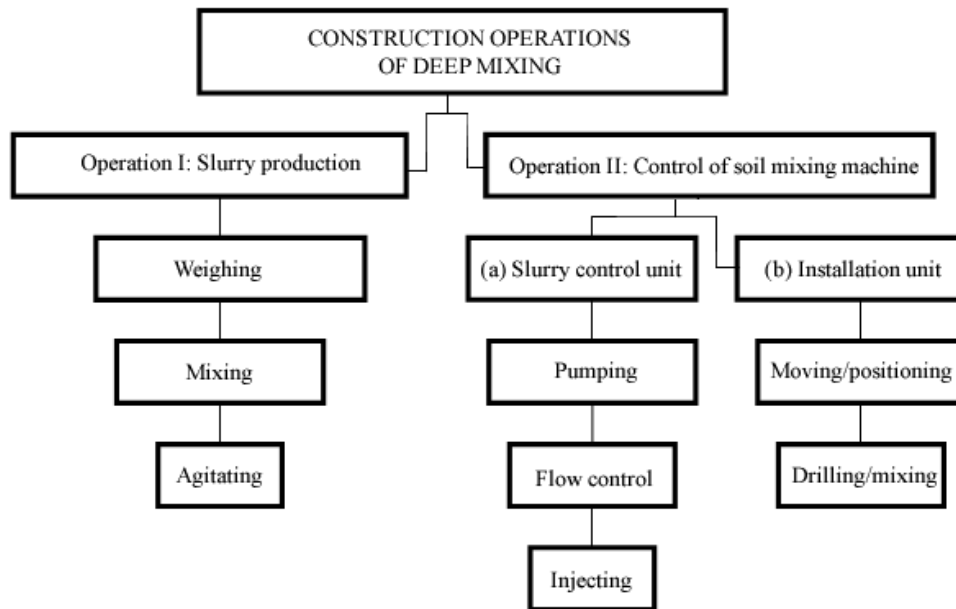

Figure 8 – 1. Construction Operation Flowchart (After Porbaha et. al., 2001)

8.2 CONSTRUCTION TECHNIQUES

Specifically designed equipment is used for construction of DM excavation support walls. The equipment includes two primary units, the drilling/mixing machinery and the batch mixing plant. The drilling/mixing equipment is typically a multiple axis auger consisting of a multi–axis gearbox, electric driven engine, joint bands, drilling/mixing shafts and three to four auger heads as shown in Figure 8 – 2 and Figure 8 – 3(a–c).

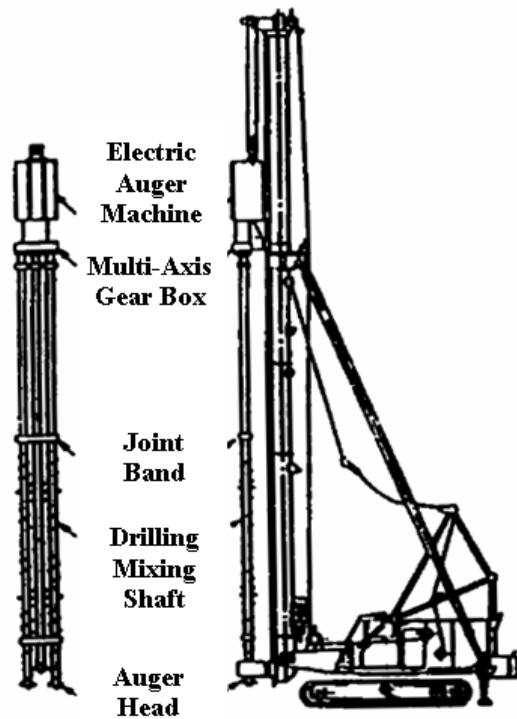

Figure 8 – 2. Three Auger DM Equipment (After Taki and Yang, 1991)

As described by Taki and Yang (1991), the DM machine is guided by a vertical steel lead on a track-mounted base supported at three points during operation. Vertical alignment must be controlled to eliminate unmixed zones between column sets, and to allow and maintain the continuity of the deep mixed wall. The joint bands provide rigidity to the mixing shafts and maintain spacing between the augers. The auger flights and mixing paddles overlap allowing for three or four soil cement columns to be constructed during each pass. Adjacent augers rotate in opposite directions to mix the soils with the grout at the specified depth. Unlike traditional continuous augers, the soil is not moved upward during rotation. Typically auger/paddle design is chosen based on different types of soil and tailored to meet the project requirements. The penetration and withdrawal speeds are determined by the properties of soil and mixing effort required for the DM design properties. The slurry flow rate is adjusted constantly due to the varying soil strata and changes in penetration speed.



(a) M250 DMM Rig [Photos by Jakiel (2000) and McGinn]



(b) M250 Auger Configurations
[Photos after Jakiel (2000)]



(c) 608 Rig (Photo by Mason)

Figure 8 – 3. DM Equipment at CA/T Project, Boston, MA
(After McGinn and O'Rourke, 2003)

The batch mixing plant (Figure 8 – 4) is used to produce the slurry mixture and is automated to measure the amount of water, cement and additives. The mix design components are measured by weight which is entered at the control panel. This allows for the mix design to be easily changed by the contractor at the control panel. The slurry is supplied to each auger by separate positive displacement pumps.

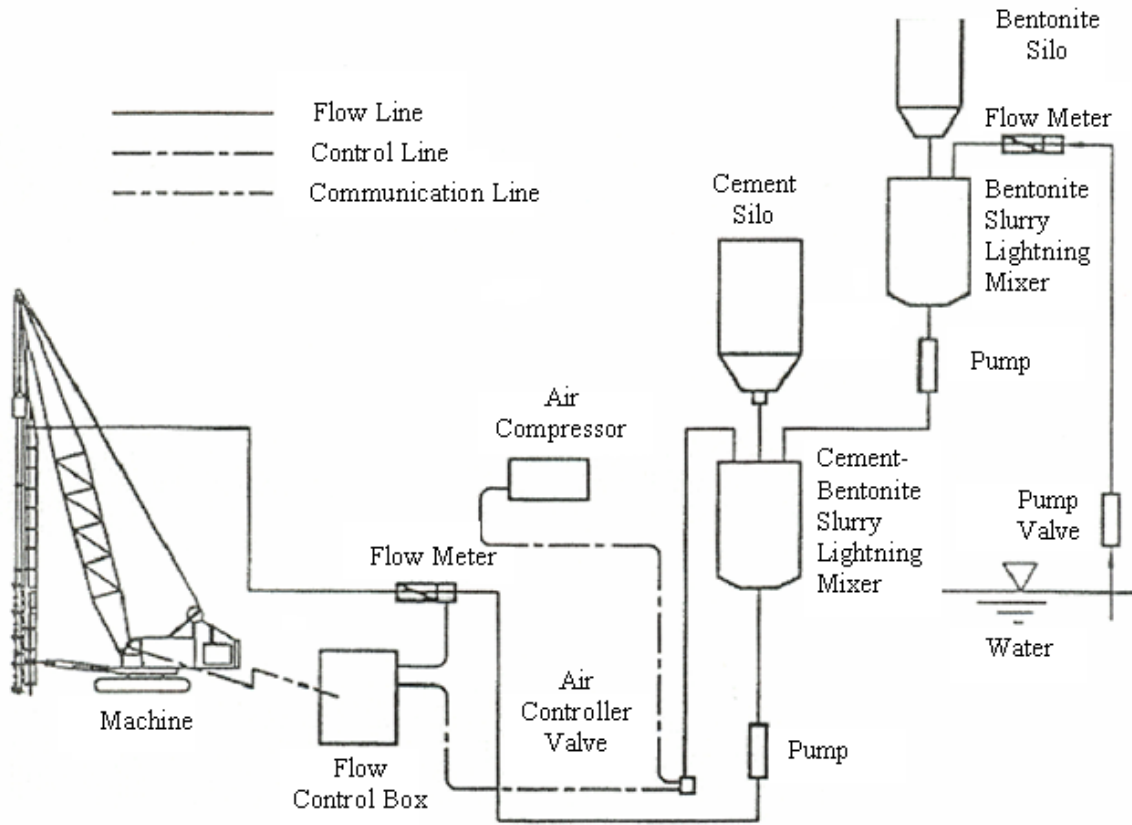

Figure 8 – 4. Batch Mixing Plant (After Bahner and Naguib, 1998)

The construction procedures are illustrated in Figure 8 – 5. The trench is prepared and the template of alignment set. The cement is prepared in the batch mixing plant and then the DM work starts. The steel wide flange beams are installed after the completion of the first few sets of columns, before the soil cement begins to set.

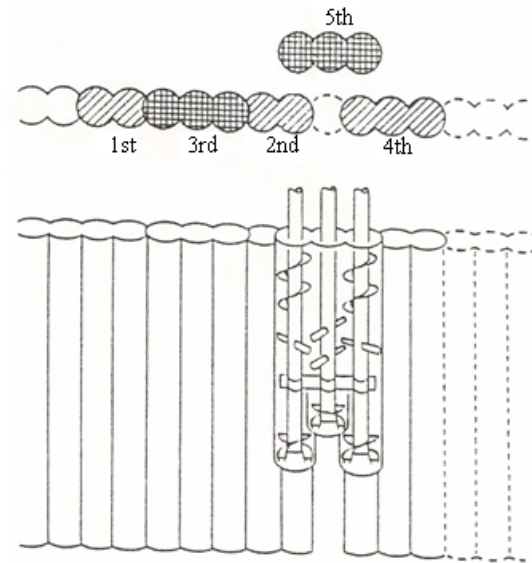

Figure 8 – 5. DM Wall Installation Process (After Yang and Takeshima, 1994)

8.3 SPOILS

Some spoils are produced during the construction of the excavation support wall due to the loosening and mixing of in situ soil. Because most of the slurry is used in the wall construction, the volume of spoils is smaller than those of other types of excavation construction methods (Taki and Yang, 1989). Often the spoils are allowed to harden to facilitate in transportation from the site. Compared to traditional techniques, the cost of transporting the spoils decreases because the soil is mixed in situ rather than replaced, and the net quantity of excess material is considerably less (Porbaha et al., 1998).

8.4 PRE-CONSTRUCTION TESTING

Test columns can be constructed at project locations to calibrate the construction procedure and to obtain more accurate design parameters. The mix design can also be calibrated with pre-construction laboratory and site testing.

8.5 PERFORMANCE DURING CONSTRUCTION

Ando et al. (1995) found that the environmental impacts during the construction of deep mixing are minimal compared with other soil improvement methods. Both vibration and noise disturbances are minimized as well as ground displacement during construction. This is a distinct advantage of deep mixing over other types of excavation support methods.

8.6 SPECIFICATIONS

Example specifications are given in Appendix B.

CHAPTER 9

QUALITY ASSESSMENT AND PERFORMANCE MONITORING

9.1 INTRODUCTION

In the literature, quality assessment and performance monitoring are often used interchangeably. For the purpose of the manual, quality assessment refers to procedures related to the installation of the DM wall. Performance monitoring refers to the procedures related to the wall during excavation.

9.2 QUALITY ASSESSMENT METHODS

Quality assessment of mixing and construction is of great importance to ensure the continuity and homogeneity of the excavation support wall. For success of DM installation, quality assessment steps illustrated in Figure 9 – 1 should be used. Strength and permeability tests are also performed to ensure the wall meets design specifications. The slurry mixture condition, vertical alignment, penetration/withdrawal speeds, and flow of slurry contribute to the quality of the final DM wall.

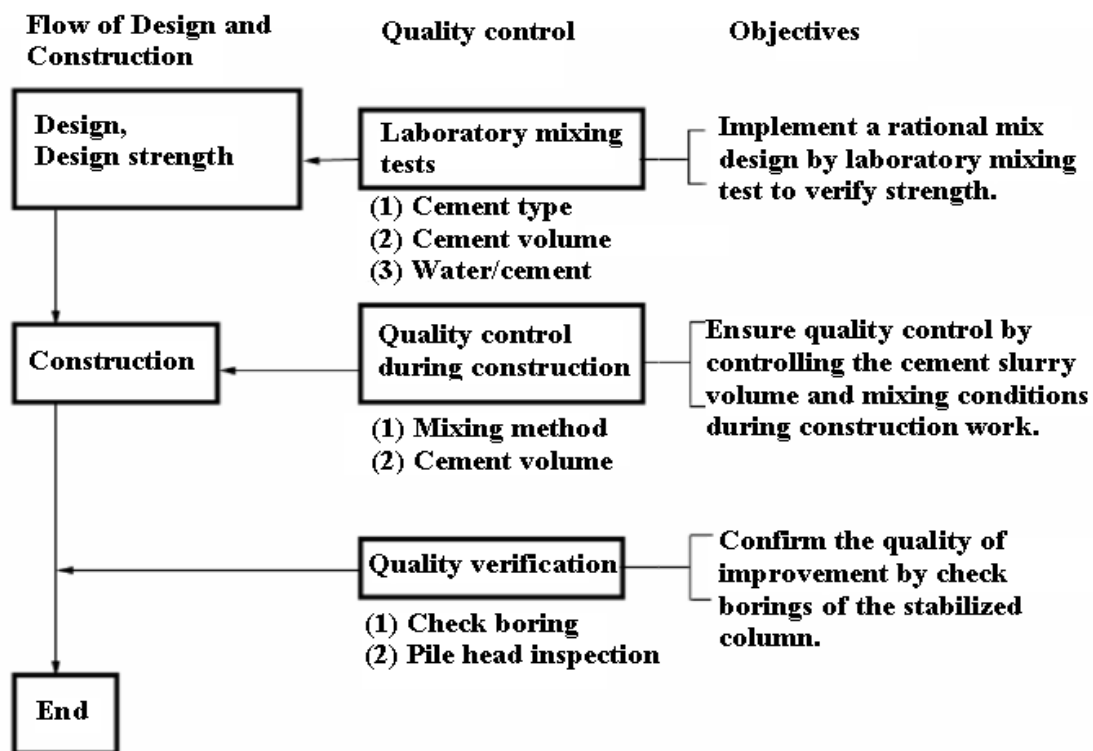

Figure 9 – 1. Flowchart for Quality Control and Quality Assurance (After Coastal Development Institute of Technology (eds.), 2002)

Multiple methods of quality assessment have been developed for deep mixing construction. Examination of the documentation of cement source and quality, records of cement mixing quantities and results of on-site tests for compressive strength of partially cured soil cement samples should always be included in the quality assessment program (Sabatini et al., 1997). During installation of the wall, the following mixing and positioning parameters should be monitored (Sabatini et al., 1997):

- Shaft rotation during penetration and withdrawal
- Velocity of shaft withdrawal
- Cement content of soil cement mixture
- Pumping rate of soil cement slurry mixture
- Amount of overlap between adjacent piles
- Horizontal and vertical alignment

Both laboratory and field testing are used to determine and control the design parameters for the wall. Prior to the construction of the soil cement wall, testing is performed on the samples prepared in the laboratory using in situ soil. Laboratory testing should be performed when no previous data is available or where the in situ soils contain material deleterious to soil cement (Taki and Yang, 1991). Selection of mixing equipment, installation parameters and procedures can be left to the Contractor. Maswoswe (2001) describes the specifications for in situ soil cement mix in the Central Artery/Tunnel (CA/T) project:

***Unconfined compressive strength (UCS)** – minimum and maximum 56-day strength of 2.1 and 6.9 MPa, respectively. This was to be evaluated primarily by taking fluid samples directly from select freshly installed soil cement columns (Takenaka, 1995) at three depth intervals. The samples were to be cast, cured and tested in the CA/T laboratory. It was recognized that these samples would probably contain a larger proportion of grout to clay and would therefore overestimate in situ strength. To minimize this impact, it was specified that (1) the trap door sampler be large enough to retrieve potentially untreated soil lumps of 15cm maximum size, and (2) those lumps be broken up and incorporated into 15cm-diameter by 30cm-high samples.*

***Homogeneity/uniformity** – evaluated by taking **continuous cores** at a minimum of 40 selected locations. UCS test would also be performed on representative samples for comparison with fluid sample strengths. To minimize disturbance and maximize recovery, cores were to be obtained using a 10cm-I.D. double tube core barrel.*

Vertical tolerance – no more than 2% horizontal deviation with depth in any direction. This was to be evaluated at regular intervals by installing an inclinometer in one of the auger stems when at maximum depth.

Auger penetration – at least 0.3 m into glacial deposits to increase friction at the soil cement/glacial interface. This was to be assessed primarily by evaluating the cores.

Unit weight – minimum of 105 pcf based on weight and volume of core samples.

9.3 CORE SAMPLING AND TESTING

Field samples from the soil cement columns are obtained to insure the wall meets strength and permeability requirements. As shown in Figure 9 – 2, a sampler is used at the designated depth to retrieve a soil cement bulk sample immediately after column installation. The test cylinders are prepared from the bulk samples retrieved from the columns. Unconfined compressive strength tests, direct shear tests, and triaxial compression tests are used to evaluate the strength characteristics of soil cement (Taki and Yang, 1991).

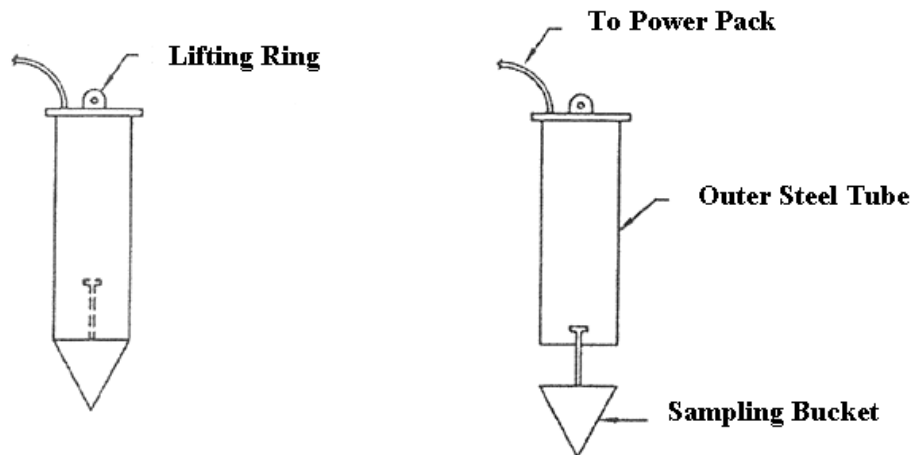

Figure 9 – 2. Sampling Tool (After Bahner and Naguib, 1998)

The permeability test is generally performed in the laboratory using samples prepared from the soil cement bulk sample. Pressurized water is used to test the soil cement because the coefficient of permeability is low.

9.4 IN SITU TESTING

Another method of testing the columns is the use of a reversed column penetrometer with a probe or the standard cone penetrometer test (CPT). The Legeon Test Technique can be used to perform the in situ permeability test (Holm, 2000).

9.5 MONITORING TECHNIQUES

After the installation of the soil cement columns, monitoring techniques during the excavation are very important. Instrumentation should be used to verify the alignment and wall deformations of the excavation support. During the excavation, lateral wall movements, potential bottom heave and settlement of areas behind the wall should be inspected and monitored carefully. Conventional techniques include the use of surveying, heave points, settlement plates, extensometers, inclinometers and other sophisticated measurement tools. Field instrumentation is important for accurate monitoring of DM excavation support. Table 9 – 1 presents types of instrumentation used to in the Central Artery/Tunnel (CA/T) project in Boston, MA (Dunnicliff et al., 1996).

Table 9 – 1. Types of Instruments Used (After Dunnicliff et al., 1996)

Instrument Type	What is Measured	How Measured
<i>Deformation</i>		
Deformation Monitoring Point	Surface Vertical & Horizontal Deformation	Optical Survey
Convergence Gage	Convergence Across Excavation or Tunnel	Portable Mechanical Tape Extensometer
Utility Monitoring Point	Vertical Deformation of Utility	Optical Survey
Borros Point	Subsurface Settlement: Single Point	Optical Survey
Settlement Platform	Settlement of Original Ground Surface Below Fill	Optical Survey
Probe Extensometer	Subsurface Settlement: Multi–Point	Electrical Probe
Inclinometer	Subsurface Horizontal Deformation	Electrical Probe
Multi–Point Heave Gage	Heave Below Bottom of Excavation	Electrical Probe
Crack Monitor	Opening & Closing of Crack in Structure	Portable Mechanical Gage or Fixed Grid Gage
Tiltmeter	Rotational Deformation	Plug–In Electrical Readout Unit
<i>Groundwater Pressure</i>		
Observation Well	Groundwater Level in Granular Fill	Electrical Probe
Vibrating Wire Piezometer	Groundwater Pressure in Other Materials	Plug–In Electrical Readout Unit
<i>Stress & Load in Temporary Supports</i>		
Vibrating Wire Strain Gage	Strain on Surface of Steel (From Which Stress Is Calculated)	Datalogger or Plug–In Electrical Readout Unit
Load Cell on Tieback	Load in Tieback	Plug–In Electrical Readout Unit
<i>Vibration</i>		
Seismograph	Vibration	Automatic Recording

REFERENCES

- American Association of State Highway and Transportation Officials (AASHTO). (1990). *Specification for Permanent Ground Anchors*; AASHTO–AGC–ARTBA Joint Committee Task Force 27 Report, Washington DC.
- Anderson, T. C. (1998). "Anchored Deep Soil Mixed Cutoff/Retaining Walls for Lake Parkway Project in Milwaukee, WI." *Design and Construction of Earth Retaining Systems*, ASCE, Geotechnical Special Publication No. 83, 1–13.
- Ando, Y., Tsuboi, H., Yamamoto, M., Harada, K., and Nozu, N. (1995). "Recent Soil Improvement Methods for Preventing Liquefaction." *Proceeding of Earthquake Geotechnical Engineering*, Balkema, Rotterdam, The Netherlands, 1011–1016.
- Andromalos, K. B., and Bahner, E. W. (2003). "The Application of Various Deep Mixing Methods for Excavation Support Systems." *Grouting and Ground Treatment*, ASCE, Geotechnical Special Publication No. 120, 515–526.
- Bahner, E. W. and Naguib, A. M. (1998). "Design and Construction of a Deep Soil Mix Retaining Wall for the Lake Parkway Freeway Extension." *Soil Improvement for Big Digs*, ASCE, Geotechnical Special Publication No. 81, 41–58.
- Briaud, J.–L., and Kim, B.K. (1998). "Beam Column Method for Tieback Walls", *Journal of Geotechnical and Geoenvironmental Engineering*, 124(1), 67–79.
- Briaud, J.–L., and Lim, Y. (1997). "Soil Nailed Wall Under Piled Bridge Abutment: Simulation and Guidelines," *Journal of Geotechnical and Geoenvironmental Engineering*, 123(11), 1043–1050.
- Briaud, J.–L., and Lim, Y. (1999). "Tieback Walls in Sand: Numerical Simulation and Design Implications." *Journal of Geotechnical and Geoenvironmental Engineering*, 125(2), 101–111.
- Briaud, J.–L., Meriweather, M., and Porwoll, H. (1983). "Pressuremeter Design of Retaining Structures," Report *FHWA/TX–84/54+340–4F*, Texas Transportation Institute, Texas A&M University, report to the Texas Department of Transportation.
- Briaud, J.–L., Nicholson P., Lee J. (2000). "Behavior of a Full–Scale VERT Wall in Sand." *Journal of Geotechnical and Geoenvironmental Engineering*, 126(9), 808–818.
- Briaud, J.–L., and Tucker, L.M (1997). "Design and Construction Guidelines for Downdrag on Uncoated and Bitumen–Coated Piles." *NCHRP Report 393*, Transportation Research Board, National Academy Press, Washington DC.

- Bruce, D.A. (2000a). "An Introduction to the Deep Soil Mixing Methods as Used in Geotechnical Applications." *FHWA-RD-99-138*, Federal Highway Administration, McClean, VA.
- Bruce, D.A. (2000b). "An Introduction to the Deep Soil Mixing Methods as Used in Geotechnical Applications: Appendices." *FHWA-RD-99-144*, Federal Highway Administration, McClean, VA.
- Bruce, D.A. (2000c). "An Introduction to the Deep Soil Mixing Methods as Used in Geotechnical Applications: The Verification and Properties of Treated Ground." *FHWA-RD-99-167*, Federal Highway Administration, McClean, VA.
- Bruce, D.A., Bruce, M.E.C. and DiMileo, A. (1998). "Deep Mixing Method: A Global Perspective." ASCE, Geotechnical Special Publication No. 81, 1-15.
- Clough, G.W., and O'Rourke, T.D. (1990). "Construction Induced Movements of In-Situ Walls," ASCE, Geotechnical Special Publication No. 25, 439-470.
- Coastal Development Institute of Technology (CDIT), (2002). *The Deep Mixing Method: Principle, Design, and Construction*, A.A. Balkema Publishers, Lisse, The Netherlands.
- Duncliff, J., Daugherty, C., and Neff, T. (1996). "Geotechnical Instrumentation for the Central Artery/Tunnel Project: An Overview." *Civil Engineering Practice*, 11-20.
- Federal Highway Administration (FHWA). (1997). "Training Course in Geotechnical and Foundation Engineering: Subsurface Investigations." *FHWA HI 97-021*, McClean, VA.
- Holm, G. (2000). "Deep Mixing." *Soft Ground Technology*, ASCE, Geotechnical Special Publication No. 112, 105-122.
- Jakiel, R. (2000). "Case History: Deep Soil-Cement Mixing at the I-90/I-93 NB Interchange on the Central Artery/Tunnel Project, Contract C09A7 at Fort Point Channel Site, Boston, MA." *Proceedings 25th Annual Meeting and 8th International Conference and Exhibition*, New York, NY, Oct., Deep Foundations Institute, Englewood Cliffs, NY, 569-593.
- Koutsoftas, D. (1999). "Excavation in San Francisco Bay Mud: Design for Deformation Control." *Proceedings of the Conference American Society of Civil Engineers*, University of Illinois, Urbana-Champaign, IL, 337-392.
- Kunito, T. Honda, A., Mashima, M., and Hamasato, S. (1988). "A Study of The Relationship between Pore Structure and Coefficient of Permeability of Soil Stabilized with Cement." *Pore Structure and Permeability of Cementitious Materials, Materials Research Society Symposium Proceedings*, Boston, MA, 314-325.

- Maswoswe, J.J.G. (2001). "QA/QC for CA/T Deep Soil–Cement." ASCE, Geotechnical Special Publication No. 113, 610–624.
- Matlock, H., Bogard, D., and Lam, I. (1981). "BMCOL76: A Computer Program for the Analysis of Beam-columns under Static Axial and Lateral Loading." Program developed at the University of Texas at Austin, under grant from Fugro, Inc., and documented at Ertec, Inc., Long Beach, CA.
- McGinn, A.J. and O'Rourke, T.D. (2000). "Case Study of Excavation Base Stability in Deep Marine Clay." ASCE, Geotechnical Special Publication No. 94, 480–495.
- McGinn, A.J. and O'Rourke, T.D. (2003). "Performance of Deep Mixing Methods at Fort Point Channel." report prepared for Bechtel/Parsons Brinckerhoff, the Massachusetts Turnpike Authority, and the Federal Highway Administration at Cornell University, Ithaca, NY.
- McMahon, D. R., Maltese, P., Andromalos, K. B., and Fishman, K. L. (2001). "A DSM Wall for Excavation Support." *ASCE Geo-Institute Conference Foundation and Ground Improvement*, 670–684.
- McNab, A. (2002). *Earth Retention Systems Handbook*, McGraw–Hill Publishers, New York, NY.
- Mueller, C.G., Long, L.H., Weatherby, D.E., Cording, E.J., Powers III, W.F., and Briaud, J.–L. (1998). Summary Report of Research on Permanent Ground Anchor Walls, "Volume III: Model–scale Wall Tests and Ground Anchor Tests," Report No. *FHWA–RD–98–067*, Federal Highway Administration, McLean, VA.
- Naval Facilities (NAVFAC). (1982a). *Soil Mechanics: Naval Facilities Engineering Command Design Manual, NAVFAC DM–7.1*, U.S. Department of the Navy, Alexandria, VA.
- Naval Facilities (NAVFAC). (1982b). *Foundation and Earth Structures: Naval Facilities Engineering Command Design Manual, NAVFAC DM–7.2*, U.S. Department of the Navy, Alexandria, VA.
- Niina, A., Saitoh, S., Babasaki, R., Tsutsumi, I. and Kawasaki, T. (1977). "Study on DMM Using Cement Hardening Agent (Part 1)." *Proc. of the 17th Japan National Conference on Soil Mechanics and Foundation Engineering*, 1325–1328 (in Japanese).
- Niina, A., Saitoh, S., Babasaki, R., Miyata, T., and Tanaka, K. (1981). "Engineering Properties of Improved Soil Obtained by Stabilizing Alluvial Clay from Various Regions with Cement Slurry." *Takenaka Technical Research Report 25*, 1–21 (in Japanese).
- O'Rourke, T.D., McGinn, A.J., Dewsnap, J. and Stewart, H.E. (1997). "Performance of Excavations Stabilized by Deep Soil Mixing," report prepared for Bechtel/Parsons Brinckerhoff, the Massachusetts Highway Department, and the Federal Highway Administration at Cornell University, Ithaca, NY.

- O'Rourke, T.D., McGinn, A.J. and Dewsnap, J. (1998). "Case History of Excavation Stabilized by Deep Mixing Methods." ASCE, Geotechnical Special Publication No. 83, *Design and Construction of Earth Retaining Systems*, 41–61.
- O'Rourke, T.D. and O'Donnell, C.J. (1997a). "Deep Rotational Stability of Tiedback Excavations in Clay." *Journal of Geotechnical Engineering*, 123(6), 506–515.
- O'Rourke, T. D and O'Donnell, C.J (1997b). "Field Behavior of Excavation Stabilized by Deep Soil Mixing." *Journal of Geotechnical and Geoenvironmental Engineering*, 123(6), 516–524.
- Pearlman, S.L. and Himick, D.E (1993). "Anchored Excavation Support Using SMW." *Deep Foundation Institute*, 18th Annual Conference, Pittsburgh, PA, 101-120.
- Porbaha, A. (1998). "State of the Art in Deep Mixing Technology: Basic Concepts." *Ground Improvement*, 2(2), 81–92.
- Porbaha, A. (2000). "State of the Art in Deep Mixing Technology. Part IV: Design Considerations." *Ground Improvement*, 4(3), 111–125.
- Porbaha, A., Raybaut, J.–L., and Nicholson, P. (2001). "State of the Art in Construction Aspects of Deep Mixing Technology." *Ground Improvement*, 5(3), 123–140.
- Sabatini, P.J., Elias, V., Schmertmann, G.R., and Bonaparte, R. (1997). *Earth Retaining Systems. FHWA–SA–96–038*, Federal Highway Administration, Washington, DC.
- Sabatini, P.J., Pass, D.G., and Bachus, R.C. (1999). *Ground Anchors and Anchored Systems. FHWA–IF–99–015*, Federal Highway Administration, Washington, DC.
- Schnabel Foundation Company, *Deep Mixing Projects*. <www.schnabel.com> (May 4, 2004).
- Structural Design Criteria, Loads (1988). Technical Manual – *Army TN 5–809–1*, Air Force AFM 88–3, Chap. 1, Departments of the Army and of the Air Force.
- Taki, O. (2003). "Strength Properties of Soil Cement Produced by Deep Mixing." *Grouting and Ground Treatment*, ASCE, Geotechnical Special Publication No. 120, 646–657.
- Taki, O. and Yang, D.S. (1991). "Soil–Cement Mixed Wall Technique." ASCE Special Conference, Denver, CO, 298–309.
- Terashi, M. (1997). "Theme Lecture: Deep Mixing Method – Brief State of the Art." *Proc. of the 14th International Conference on Soil Mechanics and Foundation Engineering*, No.4, 2475–2478.

- Terzaghi, K. and Peck, R.B. (1967). *Soil Mechanics in Engineering Practice*, Second Edition. John Wiley & Sons, New York City, NY.
- Weatherby D. (1998). *Design Manual for Permanent Ground Anchor Walls*, FHWA report no. FHWA-RD-97-130, Federal Highway Administration, Washington, DC.
- Yang, D.S. (1994). “The Applications of Soil Mix Walls in the United States.” *Geotechnical News*, December, 44–47.
- Yang, D.S. (2003). “Soil–Cement Walls for Excavation Support.” *Earth Retention Systems 2003: A Joint Conference presented by ASCE Metropolitan Section of Geotechnical Group, The Deep Foundations Institute, and The International Association of Foundation Drilling*, New York City, NY.
- Yang, D.S., Scheibel, L.L., Lobedan, F. and Nagata, C. (2001). “Oakland Airport Roadway Project.” Deep Foundations Institute Specialty Seminar–Soil Mixing, St. Louis, MI, 55–71.
- Yang, D.S. and Takeshima, S. (1994). “Soil Mix Walls in Difficult Ground.” *In situ Ground Improvement Case Histories*, ASCE Convention, Atlanta, GA, 106–120.

APPENDIX A
CHARTS FOR DESIGN

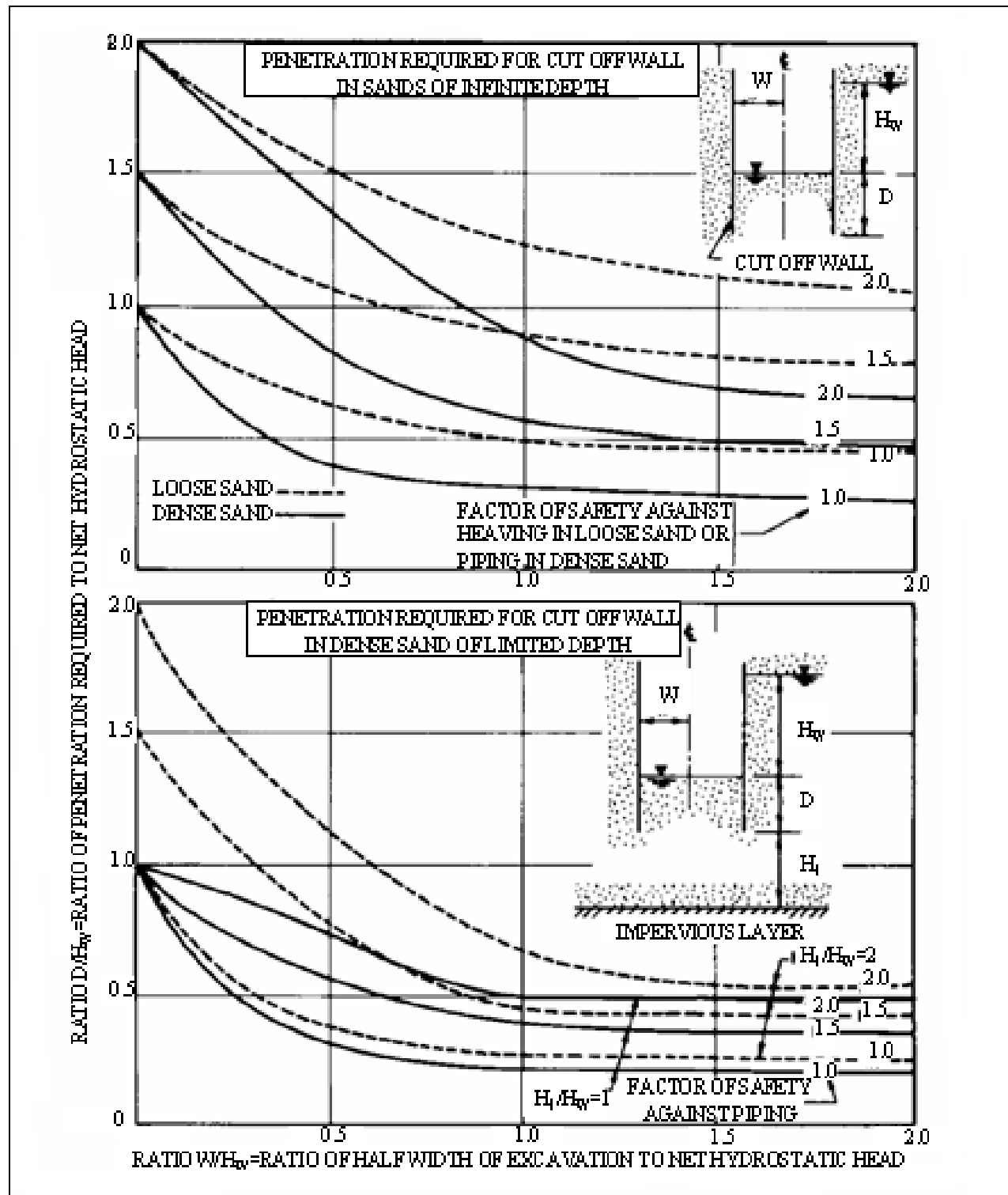
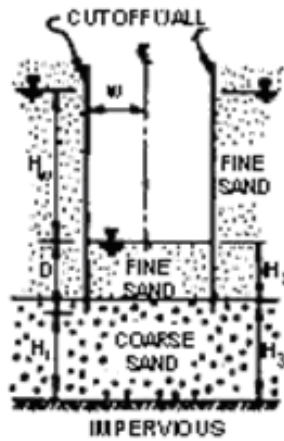

Figure A – 1. Penetration of Cutoff Wall to Prevent Piping in Isotropic Sand (After NAVFAC DM 7.1, 1982)



COARSE SAND UNDERLYING FINE SAND

PRESENCE OF COARSE LAYER MAKES FLOW IN FINE MATERIAL MORE NEARLY VERTICAL AND GENERALLY INCREASES SEEPAGE GRADIENTS IN THE FINE LAYER COMPARED TO THE HOMOGENOUS CROSS SECTION OF FIGURE 2.

IF TOP OF COARSE LAYER IS AT A DEPTH BELOW CUTOFF WALL BOTTOM GREATER THAN WIDTH OF EXCAVATION, SAFETY FACTOR OF FIGURE 2 FOR INFINITE DEPTH APPLY.

LESS THAN WIDTH OF EXCAVATION, THE UPLIFT PRESSURES ARE GREATER THAN FOR THE HOMOGENOUS CROSS SECTION. IF PERMEABILITY OF COARSE LAYER IS MORE THAN TEN TIMES THAT OF FINE LAYER, FAILURE HEAD (H_w) = THICKNESS OF FINE LAYER (H_2).

FINE SAND UNDERLYING COARSE SAND

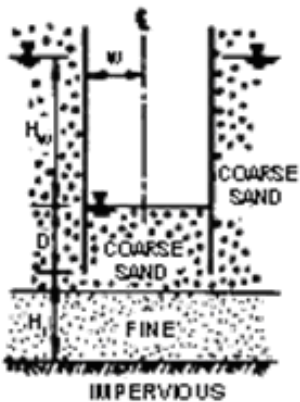

PRESENCE OF FINE LAYER CONSTRICTS FLOW BENEATH CUTOFF WALL AND GENERALLY DECREASES SEEPAGE GRADIENTS IN THE COARSE LAYER.

IF TOP OF FINE LAYER LIES BELOW CUTOFF WALL BOTTOM SAFETY FACTORS ARE INTERMEDIATE BETWEEN THOSE FOR AN IMPERMEABLE BOUNDARY AT TOP OR BOTTOM OF THE FINE LAYER USING FIGURE 2.

IF TOP OF FINE LAYER LIES ABOVE CUTOFF WALL BOTTOM SAFETY FACTORS OF FIGURE 2 ARE SOMEWHAT CONSERVATIVE FOR PENETRATION REQUIRED.

Figure A – 2. Penetration of Cutoff Wall to Prevent Piping in Stratified Sand (After NAVFAC DM 7.1, 1982)

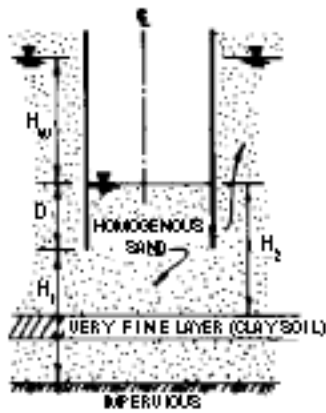

FINE LAYER IN HOMOGENOUS SAND STRATUM

IF THE TOP OF FINE LAYER IS AT A DEPTH GREATER THAN WIDTH OF EXCAVATION BELOW CUT OFF WALL BOTTOM, SAFETY FACTORS OF FIGURE 2 APPLY, ASSUMING IMPERVIOUS BASE AT TOP OF FINE LAYER.

IF TOP OF FINE LAYER IS AT A DEPTH LESS THAN WIDTH OF EXCAVATION BELOW CUT OFF WALL TOPS, PRESSURE RELIEF IS REQUIRED SO THAT UNBALANCED HEAD BELOW FINE LAYER DOES NOT EXCEED HEIGHT OF SOIL ABOVE BASE OF LAYER.

IF FINE LAYER LIES ABOVE SUBGRADE OF EXCAVATION, FINAL CONDITION IS SAFER THAN HOMOGENOUS CASE, BUT DANGEROUS CONDITION MAY ARISE DURING EXCAVATION ABOVE THE FINE LAYER AND PRESSURE RELIEF IS REQUIRED AS IN THE PRECEDING CASE..

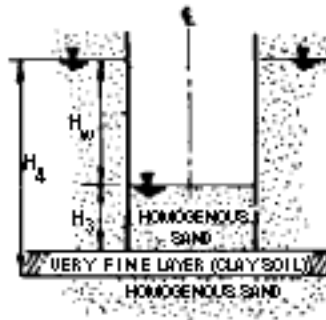

TO AVOID BOTTOM HEAVE, $\gamma_T \times H_3$ SHOULD BE GREATER THAN $\gamma_w \times H_4$.

γ_T = TOTAL UNIT WEIGHT OF THE SOIL

γ_w = UNIT WEIGHT OF WATER

Figure A – 3. Bottom Heave
(After NAVFAC DM 7.1, 1982)

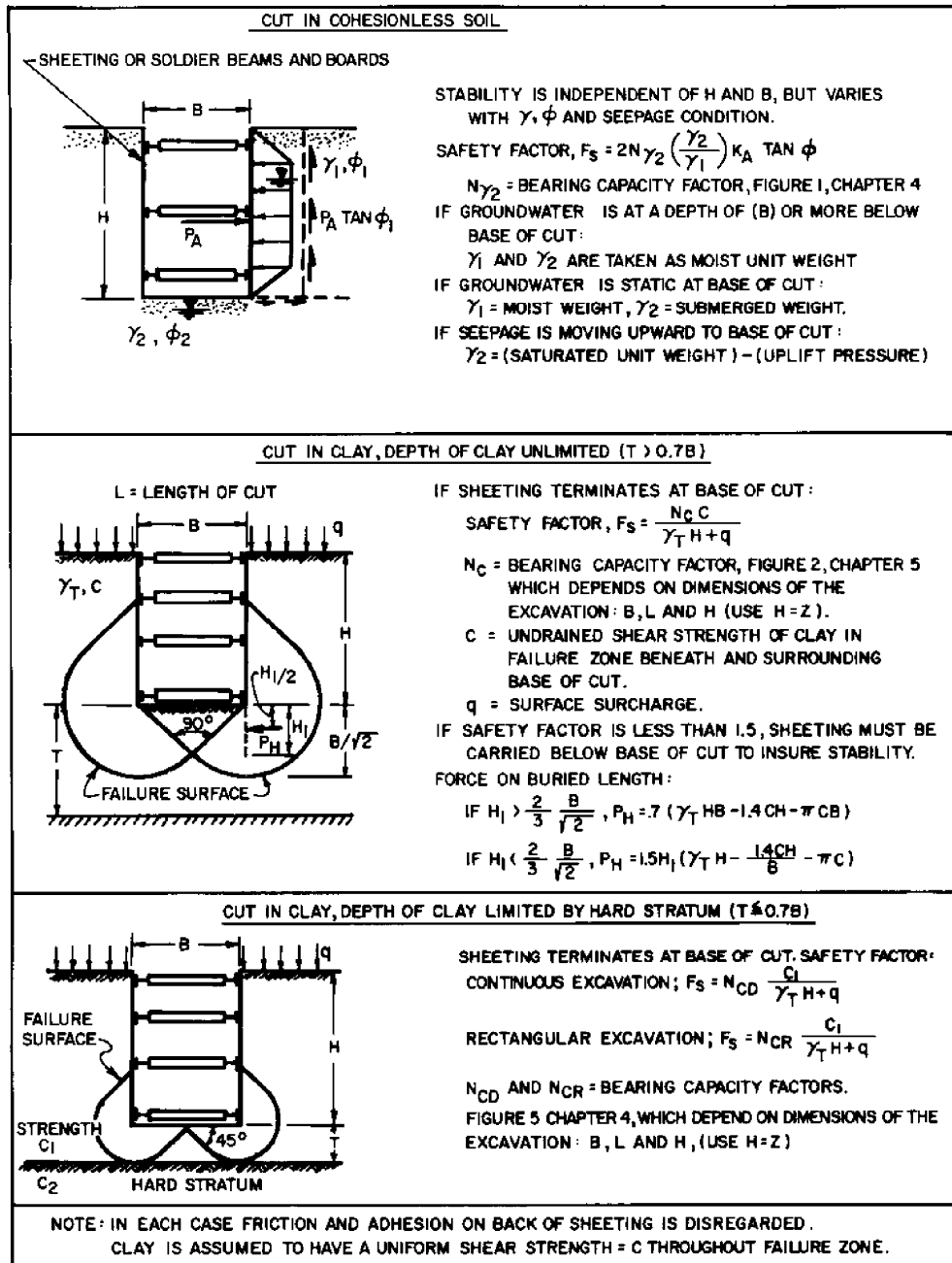

Figure A – 4. Base Stability
(After NAVFAC DM 7.2, 1982)

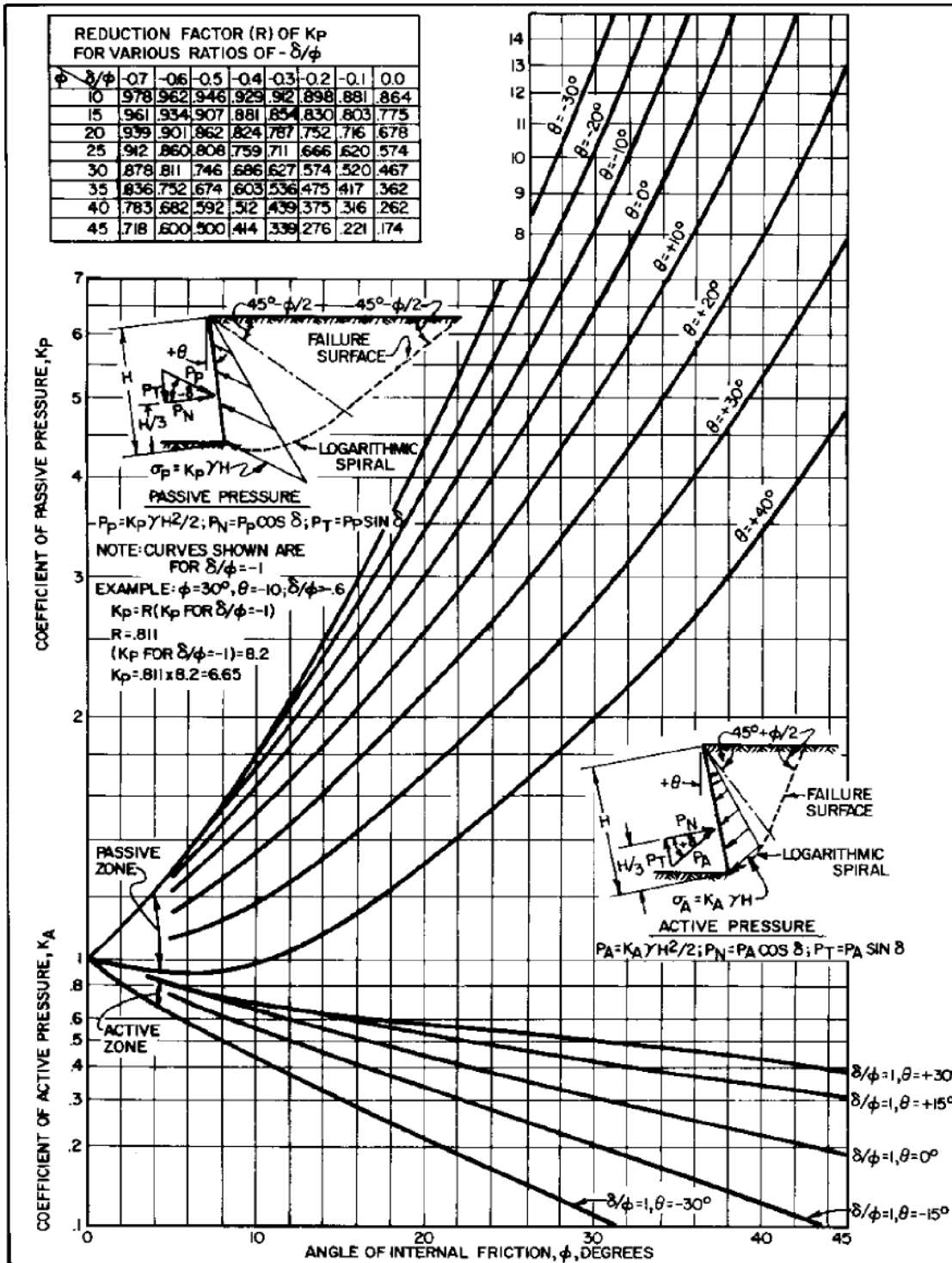

Figure A - 5. Earth Pressures for Sand
(After NAVFAC DM 7.2, 1982)

Table A – 1. Wall Friction (After NAVFAC DM 7.2, 1982)

Interface Materials	Friction factor, tan (delta)	Friction angle (delta) degrees
Mass concrete on the following foundation materials:		
Clean sound rock.....	0.70	35
Clean gravel, gravel–sand mixtures, coarse sand.....	0.55 to 0.60	29 to 31
Clean fine to medium sand, silty medium to coarse sand, silty or clayey gravel.....	0.45 to 0.55	24 to 29
Clean fine sand, silty or clayey fine to medium sand	0.35 to 0.45	19 to 24
Fine sandy silt, nonplastic silt.....	0.30 to 0.35	17 to 19
Very stiff and hard residual or preconsolidated clay.....	0.40 to 0.50	22 to 26
Medium stiff and stiff clay and silty clay.....	0.30 to 0.35	17 to 19
(Masonry on foundation materials has same friction factors.)		
Steel sheet piles against the following soils:		
Clean gravel, gravel–sand mixtures, well–graded rock fill with spalls.....	0.40	22
Clean sand, silty sand–gravel mixture, single size hard rock fill.....	0.30	17
Silty sand, gravel or sand mixed with silt or clay.....	0.25	14
Fine sandy silt, nonplastic silt.....	0.20	11
Formed concrete or concrete sheet piling against the following soils:		
Clean gravel, gravel–sand mixture, well–graded rock fill with spalls.....	0.40 to 0.50	22 to 26
Clean sand, silty sand–gravel mixture, single size hard rock fill.....	0.30 to 0.40	17 to 22
Silty sand, gravel or sand mixed with silt or clay.....	0.30	17
Fine sandy silt, nonplastic silt.....	0.25	14
Various structural materials:		
Masonry on masonry, igneous, and metamorphic rocks:		
Dressed soft rock on dressed soft rock.....	0.70	35
Dressed hard rock on dressed soft rock.....	0.65	33
Dressed hard rock on dressed hard rock.....	0.55	29
Masonry on wood (grain).....	0.50	26
Steel on steel at sheet pile interlocks.....	0.30	17
Interface Materials (Cohesion)	Adhesion (psf)	
Very soft cohesive soil (0 – 250 psf)	0 – 250	
Soft cohesive soil (250 – 500 psf)	250 – 500	
Medium stiff cohesive soil (500 – 1000 psf)	500 – 750	
Stiff cohesive soil (1000 – 2000 psf)	750 – 950	
Very stiff cohesive soil (2000 – 4000 psf)	950 – 1,300	

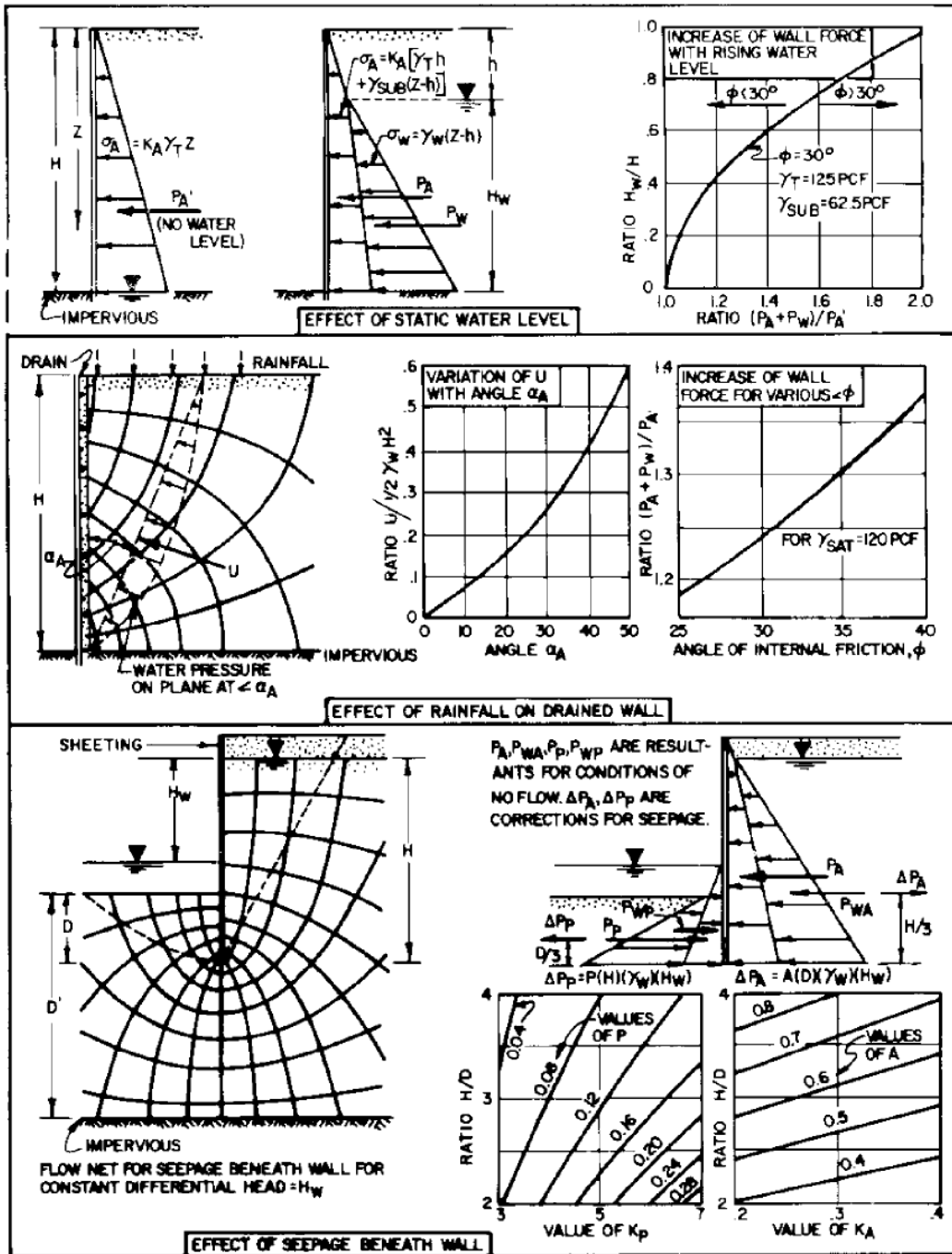

Figure A – 6. Adjusted Earth Pressures (After NAVFAC DM 7.2, 1982)

APPENDIX B
SPECIFICATIONS

**SAMPLE
SPECIFICATIONS**

FOR

SOIL–CEMENT EXCAVATION SUPPORT WALL

CONSTRUCTED BY

CEMENT DEEP SOIL MIXING (CDSM) METHOD

(CDSM EXC SUP WALL SPEC 0603a)

PROVIDED BY DR. DAVID YANG, RAITO, INC.

GENERAL

The purpose of the Cement Deep Soil Mixing (CDSM) work is to install a soil–cement wall for groundwater control and excavation support. The soil–cement wall is constructed underground using 3–foot diameter multiple axis shafts spaced at 2–foot centers. The wall is extended to the low permeability stratum to cutoff the groundwater from entering to the excavation. The wall is also reinforced with steel H–piles and extended to a competent soil stratum to maintain the stability of excavation in conjunction with a bracing or anchoring system.

1. SCOPE OF WORK

1.A General Conditions and Requirements

1.A.1 The scope of work consists of performing the CDSM work and specified quality control program, and furnishing all the required supervision, labor, equipment, tools, supplies, materials, fuel and transportation for performing and testing the CDSM work in accordance with this specification and referenced drawings.

1.A.2 CONTRACTOR shall obtain clearance from ENGINEER before beginning work in order to avoid interference with underground conduits, pipes, storage tanks, etc. CONTRACTOR shall at all times maintain proper clearance of the equipment derricks from overhead interference, if any.

1.B Work Included

1.B.1 The scope of work includes, but is not limited to the items listed below.

1.B.2 Mobilizing/demobilizing the equipment, tools, supplies, materials and personnel necessary to perform the work in accordance with this specification.

1.B.3 Reviewing available pertinent information in the vicinity of the project site, regarding the subsurface conditions and site–specific geology.

1.B.4 Numbering and surveying the locations of the soil–cement walls in accordance with this specification and areas defined on the design drawings.

1.B.5 Performing the CDSM work in accordance with this specification and the drawings to produce the specified soil–cement wall in the areas defined on the drawings.

1.B.6 Obtaining, preparing, transporting, and testing soil–cement samples in accordance with this specification.

1.B.7 Maintaining complete daily records for all field operations and furnishing them to ENGINEER in accordance with this specification.

1.B.8 Providing all submittals listed in this specification.

1.C Work Not Included

1.C.1 Geotechnical Engineering services related to foundation analysis and design are not included in the scope of this work.

1.C.2 Items Furnished by OWNER or ENGINEER

1.C.3 Water suitable for cement slurry mix (not saltwater unless approved by ENGINEER).

2. DEFINITIONS

2.A CDSM Panel: A soil–cement panel constructed by treating soils in–situ by cement deep soil mixing technology. The CDSM panel, consisting of multiple overlapped soil–cement columns, is formed by using multiple–axis soil mixing shafts guided by a lead mounted on a crawler base machine. The mixing shafts are driven by a power source sufficient to provide torque for a wide range of drilling conditions. As the mixing shafts are advanced into and/or withdrawn from the soil, cement slurry is pumped through the hollow stem of the shafts and injected into the soil from ports near the shaft tips. The cement slurry is predominantly Portland cement, although it may contain pozzolans and other specific additives. Mixing blades and/or auger flights on the shafts must be capable of thoroughly blending the soil with the cement slurry to produce a uniform soil–cement panel that remains in the ground. With multi–shaft mixing rigs, the mixing shafts are positioned so as to overlap one another to form continuously mixed overlapping columns. The process is then repeated to form a continuous wall.

2.B Mix Design: Proportions of all materials used to produce the soil–cement.

2.C Cement Slurry: A mixture of Portland cement, bentonite, water, and other admixtures, pozzolans or additives used to increase the strength of the in–situ soil.

2.D Cement Dosage: The amount of cement injected to treat a given volume of in–situ undisturbed soil expressed in pounds per cubic yard.

2.E Slurry Injection Rate: The amount of slurry injected per minute during penetration and during withdrawal expressed in gallons per minute (gpm).

2.F Water–Cement Ratio: The ratio of weight of water to dry weight of cement and admixture used in the slurry mix design.

3. SUBMITTALS

- 3.A Construction Drawings:
CONTRACTOR shall prepare and submit drawings defining the detailed arrangement and spacing of the CDSM Panels as indicated on the design drawings. The construction drawings shall also define the CDSM Panel numbering and/or identification system to be implemented by CONTRACTOR. The drawings shall be submitted for approval by ENGINEER prior to the start of work, and shall be adhered to by CONTRACTOR during execution of the work.
- 3.B Materials:
- 3.B.1 Cement: Certificate for each shipment.
- 3.B.2 Admixtures/Pozzolans/Additives: Certificate for each shipment, if used.

4. REFERENCE STANDARDS

The following standards shall apply to the extent referenced within the text of this specification. The revision or date of issue of the standards in effect at date of this contract shall apply.

- 4.A American Society for Testing and Materials (ASTM)
ASTM C150 –Standard Specification for Portland Cement
ASTM D2166 – Standard Test Method for Unconfined Compressive Strength of Cohesive Soils
ASTM D4380 – Standard Test Method for Density of Bentonitic Slurries
ASTM D4832 – Standard Test Method for Preparation and Testing of Controlled Low Strength Material (CLSM) Test Cylinders
ASTM D5084 – Standard Test Method for Measurement of Hydraulic Conductivity of Saturated Porous Materials Using a Flexible Wall Permeameter
- 4.B American Petroleum Institute (API)
API Standard 13A Specifications for Oil–Well Drilling Fluid Materials

5. PRODUCTS

5.A MATERIALS

- 5.A.1 Cement: Cement used in preparing the reagent shall conform to ASTM C150. The proposed “type” of cement as described in the ASTM standard shall be approved by ENGINEER before it is used on the project. The cement shall be

adequately protected from moisture and contamination while in transit to and in storage at the job site. Reclaimed cement or cement containing lumps or deleterious matter shall not be used.

- 5.A.2 Bentonite: Bentonite shall conform to API Standard 13A. Chemically treated bentonite shall not be allowed.
- 5.A.3 Water: Water, free of deleterious substances that adversely affect the strength and mixing properties of the slurry, shall be used to manufacture cement slurry. Fresh water shall be used unless otherwise approved by ENGINEER.
- 5.A.4 Admixtures: These are reagents other than Portland cement and water that are added to the mixture immediately before or during mixing. Admixtures of softening agents, dispersions, retarders or bridging agents may be added to the water or the slurry to permit efficient use of materials and proper workability of the slurry, except as approved by ENGINEER.
- 5.A.5 Pozzolans and Additives: Additional solids such as ground slag, quicklime, or bentonite shall not be used in the mix design, except as approved by ENGINEER.

6. EQUIPMENT

- 6.A The CDSM equipment shall meet the following requirements:
 - 6.A.1 Multi-shaft mixing equipment that mechanically mixes the soil and cement slurry for the full dimensions of the panel shall be used. The mixing shafts shall have mixing augers and/or blades (paddles) configured in such a manner so that they are capable of thoroughly blending the in-situ soils and cement slurry. The power source for driving the mixing shafts shall be sufficient to maintain the required mix tool (shaft) rotation speed in revolutions per minute (RPM) and penetration/withdrawal rates from the ground surface to the maximum depth required.
 - 6.A.2 The CDSM equipment shall be equipped with electronic sensors built into the leads to determine vertical alignment in two planes (at 90 degrees in plan from each other): fore-aft and left-right. The output from the sensors shall be routed to a console that is visible to the operator and ENGINEER during penetration. The sensors shall be calibrated at the beginning of the project and once every 12 weeks throughout the duration of the project or as needed. The calibration data shall be provided to ENGINEER. The console shall be capable of indicating the alignment angle in each plane.
 - 6.A.3 The CDSM equipment shall be equipped with depth measuring device to allow ENGINEER to confirm during construction the penetration depth to within 2 inches.

- 6.A.4 For slurry mixing systems, the cement shall be premixed in a mixing plant that combines dry materials and water in predetermined proportions. The mixing plant shall consist of a slurry mixer, slurry agitator, slurry pump, batching scales, and a computer control unit. Dry materials shall be stored in silos. Automatic batch scales shall be used to accurately determine mix proportions for water, cement, and pozzolans or additives, if used, by weight during slurry preparation. Calibration of mixing components shall be done at the beginning of the project and after each movement of the mixing plant. The calibration data shall be provided to ENGINEER. Positive displacement pumps shall be used to transfer the slurry from the mixing plant to the augers. The slurry shall be delivered to each auger by an individual positive displacement pump.
- 6.A.5 The CDSM equipment shall be equipped with sensors to monitor the mixing tool penetration/withdrawal rates, mixing tool rotation speed, and cement slurry injection rate. The output from these sensors must be visible to the operator and ENGINEER during penetration. Calibration of this equipment shall be performed at the beginning of the project and once every twelve weeks throughout the duration of the project, or as needed. The calibration data shall be provided to ENGINEER.

7. CONSTRUCTION OPERATIONS

7.A GENERAL

- 7.A.1 The CDSM walls shall be constructed in accordance with the areas, elevations and cross sections indicated on the design drawings. The panels shall be essentially vertical, shall extend through the on-site weak soils, and shall key into the stiff clay layer. The completed panel shall be a homogeneous mixture of the cement slurry and the in-situ soils. Mixing shall be controlled by mixing tool rotational speed, mixing tool penetration/ withdrawal rates, and by slurry injection rate.
- 7.A.2 The required strength of soil-cement columns are based on the cross-sectional area of CDSM panels constructed with 3-foot diameter columns spaced at 2 feet centers, which result in an average panel width of 2.7 feet.
- 7.A.3 Monitoring of installation parameters and confirmation testing will be used to verify that the acceptance criteria have been satisfied. CONTRACTOR must establish consistent procedures to be employed during CDSM panel construction to ensure a relatively uniform product is created.

7.B HORIZONTAL ALIGNMENT

- 7.B.1 CONTRACTOR shall use a survey method to accurately set the location of the proposed soil-cement panels shown on the drawings before beginning CDSM

installation. Individual panels shall be constructed within six inches of the design locations. CONTRACTOR shall provide an adequate method to allow ENGINEER to verify the as-built location of the panels during construction.

- 7.B.2 The preliminary alignment of the mixing tool may be performed by movement of the crawler-base machine. Final alignment shall be adjusted by hydraulic manipulation of the leads. One stroke of the machine shall construct a CDSM panel; the panel shall be advanced stepwise by overlapping the adjacent outside columns of the previous strokes.
- 7.B.3 Following CDSM panel construction, CONTRACTOR shall submit As-Built Drawings indicating the location of the CDSM panels in terms of project coordinates.
- 7.B.4 It is not anticipated that obstructions, such as boulders and construction debris, will be encountered. If obstructions are encountered during the deep soil mixing, CONTRACTOR shall notify ENGINEER. ENGINEER will remove the obstructions, or will otherwise define a resolution to CONTRACTOR.

7.C VERTICAL ALIGNMENT

CONTRACTOR to achieve the required overlap of adjacent panel elements and shall control vertical alignment of the panel. Two measures of verticality shall be monitored, the fore-aft and the left-right. The CDSM panels shall be installed at an inclination not deviating more than 1:80 (horizontal to vertical) from vertical at any point.

7.D PANEL TOP AND BOTTOM ELEVATIONS

The top of the CDSM panels shall extend up to an elevation not lower than that shown on the drawings. The bottom depth shall comply with the minimum required embedment of two feet into the stiff clay as shown on the drawings, or as determined by drilling refusal. The top of the stiff clay may be interpreted based on the drilling resistance in terms of current draw, as long as this method is approved by ENGINEER and is consistent with the elevation of the stiff clay indicated on boring logs or by cone penetration tests. If multiple-shaft equipment with varying mixing shaft lengths are used, the shortest shaft shall extend into the stiff clay to provide the minimum embedment shown on the drawings. The bottom depth may also be determined by drilling refusal. Refusal shall be defined as a drilling rate of 1.5ft/min (50 cm/minute) for 30 seconds if the depth of penetration is less than 2 feet.

CONTRACTOR will not be compensated for any portions of the CDSM panels that are above or below the dimensions shown on the drawings unless ENGINEER approves it.

7.E CEMENT SLURRY PREPARATION

Dry materials shall be stored in silos and protected from moisture. The air evacuated from the storage silos during the loading process shall be filtered before being discharged to the atmosphere. The dry materials shall be fed to the mixers for agitation and shearing. In order to accurately control the mixing ratio of slurry, the addition of water cement and pozzolans and additives shall be determined by weight using the automatic batch scales in the mixing plant. A maximum holding time of six hours shall be enforced for the slurry. The specific gravity of the slurry shall be determined during the design mix program for double checking slurry proportions. CONTRACTOR shall check the specific gravity of the slurry at least twice per shift per rig using the methods outlined in ASTM D4380. The specific gravity measurements shall be indicated on the Daily Quality Control (QC) Report.

7.F SOIL-CEMENT MIXING

Installation of each column shall be continuous without interruption. If an interruption of more than 4 hours occurs, the panel shall be remixed for the entire height of the element using the correct dosage of fresh cement grout at no cost or adverse schedule impact to ENGINEER.

The completed panel shall be a homogeneous, macro-uniform mixture of the cement slurry and the in-situ soils. Soil and slurry shall be mixed together in-place by mechanical mixing tools for the full width of the panel. Jetting shall not be used to facilitate penetration of the mixing tool. The mixing action shall blend, circulate and knead the soil over the vertical height of the panel.

7.G ROTATIONAL SPEEDS AND PENETRATION/WITHDRAWAL RATES

The rotational speeds (RPM) and penetration/withdrawal rates of the mixing shaft may be adjusted to achieve adequate mixing. The required mixing speed/rate for various soil layers encountered shall be established during the early stage of construction. The mixing speeds/rates established during the early stage of construction shall be used during the balance of the work. For production quality control, the real time monitoring of the rotational speeds and penetration/withdrawal rates of the mixing shaft shall be performed. After construction of each panel, the data recorded shall be processed and presented as shaft rotation number per 3-foot vertical interval and average penetration/withdrawal rate for every 3-foot vertical interval of soil-cement panel. These processed data shall be included in the Daily Quality Control (QC) Reports for submittal.

7.H CEMENT SLURRY INJECTION

The total quantity of cement slurry injected shall be in accordance with the mix design established during the early stage of construction. The reagent injection

rate shall be constantly monitored, calculated, and controlled. For production quality control, the real time monitoring of the slurry injection rate shall be performed. After construction of each panel, the data recorded shall be processed and presented as average injection rate for every 3-foot vertical interval of soil-cement column. These processed data shall be included in the Daily QC Reports for submittal.

ENGINEER may request that the established mix design and injection ratio be modified. The modifications are subject to approval by ENGINEER, and ENGINEER may request additional QC testing to verify acceptable results at no cost or adverse schedule impact to OWNER.

7.I CONTROL OF SPOILS

CONTRACTOR shall control all spoils created during the CDSM panel installation. The spoils shall be contained near the working area for aeration and then disposed off site by others.

7.J INSTALLATION OF H-PILES

In area where the soil-cement walls are to be used for both groundwater control and shoring, wide-flange H-piles shall be installed in the soil-cement wall before the soil-cement has set. Care shall be taken to insure that the H-pile is kept in alignment and that the proper spacing between H-piles is maintained. The H-pile shall be held in position until the soil-cement sets to insure that the proper upper and lower elevations are maintained.

8. QUALITY CONTROL PROGRAM

8.A General

8.A.1 The CDSM Quality Control (QC) Program shall be the responsibility of CONTRACTOR and shall include, as a minimum, the following components:

8.A.1.a Real time monitoring of the following soil mixing parameters:

- Drilling and mixing depth
- Auger penetration and withdrawal rates
- Auger rotational speed
- Slurry injection rate for each soil mixing shaft

8.A.1.b Testing of selected samples recovered.

8.A.2 CONTRACTOR shall provide all the personnel and equipment necessary to implement the QC Program. In addition, ENGINEER will observe construction and will review CONTRACTOR's Daily QC Reports and test results in order to verify that the QC Program is being properly implemented.

- 8.A.3 The established QC Program shall be maintained throughout the soil mixing operation to ensure consistency in the CDSM panel installation and to verify that the work complies with all requirements indicated in the drawings and specifications.

8.B. Sample Collection and Testing

- 8.B.1 The soil–cement produced by in situ soil mixing shall satisfy the strength and permeability requirements as defined in the Acceptance Criteria. One wet soil–cement bulk sample per day or one from every 5000 square feet of wall installed shall be retrieved before the hardening of the soil–cement. The bulk samples shall be taken using a special sampling tool at approximately the mid–depth of the soil–cement columns or at the depth determined by the ENGINEER. The Engineer may change the sampling depth each day.
- 8.B.2 Verification of Strength and permeability: Three–inch diameter molds shall be used to cast cylinder samples for laboratory testing. Gravel or clumps with sizes greater than the opening of a No. 4 sieve shall be manually removed from the samples. The wet samples shall be poured into the molds and vibrated to remove trapped air pockets and then sealed. The samples shall be cured in a constant temperature and damp environment until testing.

One 28–day sample from each bulk sample taken from a single sample location shall be subjected to unconfined compressive strength test in accordance with ASTM D2166 to ensure that strength requirements are being met. One 28–day sample from each bulk sample taken from a single sample location shall be subjected to permeability testing in accordance with ASTM D5084.

All testing results shall be submitted with the Daily Quality Control Report.

8.C Daily Quality Control Report

- 8.C.1 CONTRACTOR shall submit Daily QC Reports to ENGINEER at the end of the next working day. The Daily QC Report shall document the progress on the CDSM panel construction, present the results of the QC parameter monitoring, present the results of the strength and permeability testing on wet samples.
- 8.C.2 The Daily QC Report shall include at a minimum the results of the following QC parameters monitoring for each panel:
- 8.C.2.a Identification of Area of Work or Foundation
 - 8.C.2.b Rig number
 - 8.C.2.c Date and time (start and finish) of panel installation

- 8.C.2.d Panel number and reference drawing number
 - 8.C.2e Panels top and bottom depths or elevations
 - 8.C.2.f Slurry injection volume designation
 - 8.C.2.g Slurry specific gravity measurements
 - 8.C.2.h Test methods and results
 - 8.C.2.i Description of obstructions, interruptions, or other difficulties found during installation and how they were resolved
- 8.C.3 The Daily QC Reports should also include the following parameters derived from the real time QC records for each panel at 3-foot intervals and submitted in the form of either tables or figures.
- 8.C.3.a Shaft rotation number per 3-foot vertical interval vs. depth
 - 8.C.3.b Penetration and withdrawal rates in feet per minute vs. depth
 - 8.C.3.c Quantity of slurry injection of each column at every 3-foot vertical interval vs. depth

9. ACCEPTANCE CRITERIA

The in-place soil-cement walls shall meet the following acceptance criteria:

- 9.A The CDSM panels shall be installed within the following geometric tolerances:
 - 9.A.1 The horizontal alignment of the panels shall be within 6 inches of the planned location.
 - 9.A.2 The vertical alignment of the panels shall be no more than 1:80 (horizontal to vertical).
 - 9.A.3 The bottom of columns shall be at least as deep as shown and noted on the drawings, or as modified by ENGINEER in the field using drilling refusal defined by drilling rate and resistance in amperage.
- 9.B The CDSM panels shall achieve the following strength and permeability requirements:

9.B.1 The soil–cement shall achieve a minimum unconfined compressive strength of 60 psi and an average unconfined compressive strength of 90 psi at 28 days. The average strength shall be computed by summing all individual strength tests conducted by CONTRACTOR on the samples retrieved from five consecutive testing locations and dividing by the number of tests. The average coefficient of permeability shall be 2×10^{-6} cm/sec. If the 28–day average permeability testing result is greater than 2×10^{-6} cm/sec, the CONTRACTOR shall conduct additional permeability testing, without additional cost, at 56–day or 90–day curing age to verify that the permeability of soil–cement wall meets the specifications.

SECTION 02345

CEMENT DEEP SOIL MIXING

(Revised to adopt statistical control over lower range of strength distribution)

PART 1 – GENERAL

1.01 SCOPE

- A. In accordance with the specifications contained in this Section and as shown on the Plans, the Contractor shall furnish all plant, equipment, labor, and materials required to construct Cement Deep Soil Mixing (CDSM) test section and production walls at the locations and elevations indicated on the Plans.
- B. The purpose of the CDSM walls is to stabilize the shoreline slopes to resist both static and seismic loads. The stabilization plan consists of a series of continuous walls formed underground using overlapping CDSM columns. The dimensions and layout of CDSM walls are shown on the Plans and are described in Paragraph 3.01.B

1.02 REFERENCES

- A. American Concrete Institute (ACI)
- B. American Society of Testing and Materials (ASTM)
- C. American Petroleum Institute (API)

1.03 DEFINITIONS

- A. CDSM Wall: A soil–cement wall constructed by treating soils in situ by soil–cement mixing technology.
 - 1. The CDSM wall is formed by an arrangement of at least two soil mixing shafts with overlapping augers and blades (paddles), guided by a lead mounted on a crawler base machine.
 - 2. The mixing shafts shall be driven by a power source sufficient to provide torque for the wide range of expected drilling conditions, indicated by the available boring and cone penetration test logs and other test data included in the geotechnical report.
 - 3. As the mixing shafts are advanced into the soil, grout is pumped through the hollow stem of the shafts and injected into the soil at the shaft tips. Auger flights and mixing blades on the shafts blend the soil with grout in a pugmill fashion. When the design depth is reached, the mixing shafts are withdrawn while the mixing process is continued.

4. The mixing shafts are positioned so as to overlap one another to form continuously mixed overlapping columns. After withdrawal, two (or more) overlapping soil–cement columns remain in the ground.
 5. The process is then repeated to form a continuous wall of overlapping columns.
- B. Grout: A stable colloidal mixture of water, Portland cement, and admixtures. The purpose of the grout is to assist in loosening the soils for penetration and optimum mixing, and upon setting, to strengthen the in situ soil.
- C. Grout–soil Ratio: A volumetric ratio of grout to in situ soil to be mixed.
- D. Cement Dosage: The amount of cement (in terms of dry weight) used to treat a given initial volume of in situ soil.

1.04 SUBMITTALS

- A. Evidence of conformance to the referenced standards and requirements shall be submitted for the following, in accordance with the requirements of Division 1, Submittals.
1. Cement: Certificate of compliance for each truck load delivery.
 2. Admixtures: If used.
 3. Grout Mix: Proposed mix designs including all materials and quantities and documentation of calibration of the mixing plant.
 4. Construction Schedule: Submit a detailed schedule that identifies start dates and duration of each major task in the work. The schedule should at a minimum include Information regarding equipment mobilization, equipment setup, CDSM test section, CDSM production installation, and verification testing.
 5. Equipment and Procedures: Submit a detailed description of the equipment and procedures to be used during all facets of the project including, but not limited to, construction of CDSM test section walls and production walls, monitoring the quality control parameters outlined in Paragraph 3.10, and collecting samples for laboratory confirmation testing.
 - a. Procedures should include methods for locating the walls in the field and confirming that the walls are plumb.
 - b. The contractor shall also submit the anticipated cement dosages to achieve the acceptance criteria outlined in Paragraph 3.11.

6. Column Numbering Scheme: Submit a proposed column numbering scheme prior to site mobilization.
7. Daily Quality Control Reports: Prior to construction, submit a proposed Daily Quality Control Report format for approval by the Engineer. Submit the Daily Quality Control Report at the end of the next working day. The report should be in conformance with paragraph 3.10 of this specification.
8. Calibrations: Submit all metering equipment calibration test results including mixing systems, delivery systems, alignment systems, and mixing tool rotational and vertical speed.
9. CDSM Test Results: Submit all QC test results as outlined in paragraph 3.10.
10. Record Drawing: Submit record drawings prepared by a licensed surveyor indicating the location of the CDSM walls in terms of project coordinates.

1.05 QUALIFICATIONS OF CONTRACTOR

- A. The Contractor shall submit evidence of experience and competence to construct the CDSM walls according to the requirements of Document 00450, Statement of Qualification for Construction Work.

PART 2 –PRODUCTS

2.01 MATERIALS

- A. Grout: The material added to the blended in situ soils shall be a water-based Portland cement grout. The purposes of the grout are to assist in loosening the soils for penetration and optimum mixing, and upon setting, to strengthen the in situ soils. The grout shall be premixed in a mixing plant which combines dry materials and water in predetermined proportions.
- B. Cement used in preparing the grout shall conform to ASTM C150 "Standard Specification for Portland Cement Type II. The cement shall be adequately protected from moisture and contamination while in transit to and in storage at the job site. Reclaimed cement or cement containing lumps or deleterious matter shall not be used.
- C. Bentonite (optional): Bentonite shall conform to API Standard 13A "API Specifications for Oil-Well Drilling Fluid Materials". No chemically treated bentonite shall be used.

- D. Water: Fresh water, free of deleterious substances that adversely affect the strength and mixing properties of the grout, shall be used to manufacture grout.
- E. Admixtures: Admixtures are ingredients in the grout other than Portland cement, bentonite, and water. Admixtures of softening agents, dispersions, retarders or plugging or bridging agents may be added to the water or the grout to permit efficient use of materials and proper workability of the grout. However, no admixtures shall be used except as approved by the Engineer.

2.02 EQUIPMENT

- A. The CDSM equipment shall meet the following requirements.
 - 1. Multi-shaft mixing equipment (machines with at least two soil mixing shafts with overlapping augers and blades) shall be used for this project.
 - a. The mixing shafts shall have mixing augers and blades (paddles) configured in such a manner so that they are capable of thoroughly blending the in situ soils and grout.
 - b. The power source for driving the mixing shafts shall be sufficient to maintain the required revolutions per minute (RPM) and penetration rate from a stopped position at the maximum depth required.
 - 2. The CDSM rig shall be equipped with electronic sensors built into the leads to determine vertical alignment in two directions: fore-aft and left-right.
 - a. The sensors shall be calibrated at the beginning of the project and the calibration data shall be provided to the Engineer. The calibration shall be repeated at intervals not to exceed one month.
 - b. The output from the sensors shall be routed to a console that is visible to the operator and the Engineer during penetration. The console shall be capable of indicating the alignment angle in each plane.
 - 3. The CDSM equipment shall be adequately marked to allow the Engineer to confirm the penetration depth to within 6 inches during construction.
 - 4. As a minimum, the grout shall be premixed in a mixing plant, using a batch process, which combines dry materials and water in predetermined proportions. The mixing plant shall consist of a

grout mixer, grout agitator, grout pump, batching scales, and a computer control unit.

- a. Dry materials shall be stored in silos. The dry materials shall be transported to the project site and blown into the on-site storage tanks using a pneumatic system.
 - b. The air evacuated from the storage tanks during the loading process shall be filtered before being discharged to the atmosphere.
 - c. Automatic batch scales shall be used to accurately determine mix proportions for water and cement during grout preparation.
 - d. The dry admixtures, if used for mixing with water and cement, can be delivered to the mixing plant by calibrated auger. However, the Contractor shall demonstrate that the calibrated auger can deliver the quantity of dry admixture with accuracy equivalent to that measured and delivered by weight.
 - e. Calibration of mixing components shall be done at the beginning of the project and repeated at intervals not to exceed one month thereafter.
 - f. The cement shall be adequately protected from moisture and contamination while in transit to and in storage at the job site.
Reclaimed cement or cement containing lumps or deleterious matter shall not be used.
5. Positive displacement pumps shall be used to transfer the grout from the mixing plant to the augers. The grout shall be delivered to each slurry-injecting auger by an individual positive displacement pump.
6. The CDSM rig shall be equipped with sensors to monitor the mixing tool penetration/withdrawal speed, mixing tool rotation speed, and injection rate.
- a. The output from these sensors must be visible to the operator and Engineer during penetration and withdrawal.
 - b. The Contractor may propose alternative display/monitoring systems; however, the systems must first be reviewed and approved by the Engineer prior to use.
 - c. Calibration of this equipment shall be performed at the beginning of the project and the calibration data shall be provided to the Engineer. The calibration shall be repeated at intervals not to exceed one month.

2.03 PRODUCTS

- A. CDSM Walls: The in-place grout mix together with the soils shall achieve:
1. An average unconfined compressive strengths of 100 psi and 150 psi at 28 days and 90 days, respectively, determined as outlined in Paragraph 3.10.B and as defined by ASTM D2166 "Standard Test Method for Unconfined Compressive Strength of Cohesive Soil."
 2. Not more than 5 percent of the sample tested shall exhibit an unconfined compressive strength of less than 60% of the average unconfined compressive strength.
 3. The 90-day strength testing can be waived, if the 28-day unconfined compressive strength meets the 90-day strength requirements. As an alternative, a correlation between the 28-day strength and 90-day strength for this project may be established in the early construction stage for the estimate of 90-day strength using 28-day strength data.
 4. Uniformity of soil-cement shall meet the requirement as outlined in Paragraphs 3.06.C and 3.11.

PART 3 –EXECUTION

3.01 GENERAL

- A. The CDSM walls shall be constructed to the lines, grades, and cross sections indicated on the Plans.
1. The walls shall have essentially vertical columns as stated in Paragraph 3.03, with a diameter of 36 to 40 inches, and shall extend through the on-site soils to the elevations indicated on the Plans.
 2. The completed wall shall be a homogeneous mixture of grout and the in situ soils. Mixing is to be controlled by shaft rotational speed, drilling speed, and grout injection rate.
- B. The required CDSM strengths indicated in Paragraph 2.03 are based on a wall constructed with 3-foot-diameter columns spaced on 2-foot centers, as shown on the Plans, which result in an average wall width of 2.7 feet (based on cross-sectional area).

- 1 To accommodate variations in the Contractor's equipment dimensions, the wall width may vary from that shown on the Plans, provided:
 - a. The minimum width of the wall is not less than 2.0 feet,
 - b. The maximum width of the wall is not more than 3.5 feet,
 - c. The column overlap is at least 20% of the area of a single column at surface and the vertical alignment of 1% as specified in Paragraph 3.03.A shall be maintained during the wall installation.
 - d. The average width of the wall is at least 2.7 feet.
- C. Monitoring of construction parameters and confirmation testing will be used to verify that the acceptance criteria have been satisfied.
 1. The Contractor shall establish consistent procedures to be employed during wall construction to ensure a relatively uniform product is created.
 2. These procedures are to be defined in the Equipment and Procedures Submittal (Paragraph 1.04.A.5) and subsequently modified, if necessary based on the results of the test sections.
- D. Prior to beginning production wall installation, the Contractor must construct two test sections as described in paragraph 3.10 and shown on the Plans. If directed by the Engineer, the Contractor shall also construct a third test section.
 1. The purpose of the test sections is to verify that the Contractor's proposed equipment, procedures, and mix design can uniformly mix the on-site soils and achieve the required strengths.
 2. Based on the evaluation of completed in-place CDSM walls, the Engineer will determine if the test sections yield acceptable results and whether the Contractor may proceed with the production wall construction.
- E. The grout mix/grout-soil ratio design, equipment, installation procedures, and sampling and testing methods established during the test sections shall be used for the production wall construction.
 1. The Contractor may request that the established mix design/grout-soil ratio, equipment, installation procedure, or test methods be modified: however, the Engineer may require additional testing or a new test section, at no additional cost to the Port, to verify that acceptable results can be achieved.
 2. The contractor shall not employ modified grout mix/grout-soil ratio designs, equipment, installation procedures, or sampling or testing methods until approved by the Engineer in writing.

3.02 HORIZONTAL ALIGNMENT

- A. The Contractor shall accurately stake the location of the proposed CDSM walls shown on the Plans using a licensed surveyor before beginning installation.
 - 1. The columns shall be constructed within six (6) inches of the horizontal locations shown on the Plans for the top of wall at Elevation +6 feet. In addition, the minimum 20 percent overlap of adjacent columns must be achieved at surface and the vertical alignment of 1% as specified in Paragraph 3.03A shall be maintained during the wall installation.
 - 2. The Contractor shall provide an adequate method to allow the Engineer to verify the as-built location of the wall during construction.
- B. Movement of the crawler base machine shall provide the preliminary alignment of the augers and the final alignment shall be adjusted by hydraulic manipulation of the leads.
 - 1. One stroke of the machine shall construct a CDSM panel consisting of at least two overlapping columns.
 - 2. The wall shall be advanced stepwise by overlapping the adjacent outside columns of the previous strokes.
- C. Following CDSM wall construction, the Contractor shall submit as-built drawings prepared by a licensed surveyor indicating the location of the CDSM walls in terms of project coordinates.
- D. It is not anticipated that drilling obstructions will be encountered below Elevation +6 feet.
 - 1. If an obstruction preventing drilling advancement is encountered, the Contractor shall investigate the location and extent of the obstruction using methods approved by the Engineer. The Contractor shall propose remedial measures to clear the obstruction for approval by the Engineer.
 - 2. While the investigation for an obstruction is underway, the Contractor shall continue to install columns in areas away from the obstruction location. No stand-by delay will be allowed for equipment and operations during the investigation of an obstruction.
 - 3. The Contractor will be compensated for removal or clearing of obstructions as a Changed Condition, paid in accordance with the General Conditions.
 - 4. The Contractor will not be compensated for removal or clearing of obstructions without prior approved by the Engineer.

- E. The Contractor will not be compensated for walls that are located outside of the tolerances specified in Paragraph 3.02.A.
 - 1. Further, the Engineer will review the location of misaligned walls to determine if the walls interfere with the proposed wharf construction.
 - 2. If the Engineer determines that misaligned walls will interfere with the wharf construction, the Contractor shall correct the alignment and redrill the misaligned walls and remix them to a strength that is approximately equal to that of the unimproved soil.

3.03 VERTICAL ALIGNMENT

- A. The equipment operator shall control vertical alignment of the auger stroke. Two measures of verticality shall be monitored, longitudinal and transverse to the wall alignment. The CDSM columns shall be installed at an inclination deviating no more than 1: 100 (horizontal to vertical) from vertical at any point.

3.04 WALL DEPTH

- A. Wall depths shall extend to the line and grades shown on the Plans.
 - 1. The total depth of penetration shall be measured either by observing the length of the mixing shaft inserted below a reference point on the mast, or by subtraction of the exposed length of shaft above the reference point from the total shaft length.
 - 2. The final depth of the stroke shall be noted and recorded on the Daily Quality Control Report by the Contractor. The equipment shall be adequately marked to allow the Engineer to confirm the penetration depth during construction.
 - 3. If rigs with varying mixing shaft lengths are used, the shortest shafts shall extend to the minimum wall depths indicated on the Plans.
- B. The CDSM wall bottom elevations indicated on the Plans were estimated from the available subsurface information to provide the required minimum penetration of the walls into competent soils underlying the site.
- C. If the elevations of the top of competent soils are found to be different from those estimated, the Engineer may direct the Contractor to shorten or deepen the walls and the Contractor will be compensated based on the decreased or increased square footage of wall.
- D. The Contractor shall not be compensated for any portions of the walls that are above the top elevation or below the bottom elevation of the walls shown on the Plans unless approved by the Engineer.

3.05 GROUT PREPARATION

- A. Dry material shall be stored in silos and fed to mixers for agitation and shearing. In order to accurately control the mixing ratio of grout, the addition of water and cement shall be determined by weight using the automatic batch scales in the mixing plant.
 - 1. The admixtures, if used, for mixing with water and cement, can be delivered to the mixing plant by calibrated auger. However, the Contractor shall prove that the calibrated auger can deliver the quantity of dry admixture with accuracy equivalent to that measured and delivered by weight.
- B. A minimum mixing time of three minutes and a maximum holding time of three hours will be enforced for the grout.
 - 1. The specific gravity of the (grout) shall be determined during the design mix program for double checking grout proportions.
 - 2. The specific gravity of the grout shall be checked by the Contractor at least once per shift per rig using the methods outlined in ASTM D4380. The specific gravity of the grout measured in the field should not deviate by more than 3 percent of the calculated specific gravity for the design cement ratio.
 - 3. If the specific gravity is lower than that required by the design mix, the Contractor shall add additional cement and remix and retest the grout at no cost or schedule impact to the Port.
 - 4. The grout hold time shall be calculated from the beginning of the initial mixing. If the grout density is lower than required by the mix design, the Contractor shall recalibrate batch scales and perform additional testing as requested by the Engineer at no additional cost to the Port.
 - 5. The specific gravity measurements shall be indicated on the Daily Quality Control Report.

3.06 SOIL-GROUT MIXING

- A. Installation of each column shall be continuous without interruption. If an interruption of more than 1 hour occurs, the column shall be remixed (while injecting grout at the design grout ratio) for the entire height of the element at no additional cost to the Port.
- B. The completed wall shall be a uniform mixture of cement or cement-bentonite grout and the in situ soils.
 - 1. Soil and grout shall be mixed together in place by the pugmill-type action of the specially designed overlapping augers and blades on the mixing shafts.

2. The grout shall be pumped through the mixing shafts and injected from the tip of the shafts. The shafts shall break up the soil and blend it with cement grout.
 3. The mixing action of the shafts shall blend, circulate, and knead the soil over the length of the column while mixing it in place with the grout.
- C. Over any 4-foot section of a column, the lumps of unimproved soil shall not amount to more than 20 percent of the total volume of the wall segment and any individual lump or aggregation of lumps of unimproved soil shall be no larger than 12 inches in greatest dimension.
1. Uniformity shall be determined by the Engineer through inspection of core samples.
 2. To evaluate uniformity using core samples, all lengths of unrecovered core shall be assumed to be unimproved soil.
- C. Uniformity shall be determined by the Engineer through inspection of core samples. A core is defined as a full-length continuous coring operation at a single location that extends from the top to the bottom of the CDSM panel.
1. Recovery shall be at least 90 percent for each core, except for CDSM panel produced in gravelly soils.
 2. Within a single core, the sum length of unmixed or poorly mixed soil regions or lumps that extend entirely across the diameter of the core sample (2.5 inches) shall not exceed ten (10) percent of the recovered core length. (The alternative paragraphs in green color were used in a refinery project where the soil-cement grids were used to support the concrete mat.)
- D. If any section of the wall is found not to satisfy the above criteria, the Contractor shall remix (while injecting grout at the design grout ratio) the failed section of the wall at no additional cost to the Port.
1. Unless otherwise determined by the Engineer, the extent of the failed section shall be considered to include all walls constructed during all rig shifts that occurred between the times of construction when passing tests were achieved.

3.07 SHAFT ROTATIONAL SPEED AND PENETRATION/WITHDRAWAL RATE

- A. The mixing shaft rotational speed (measured in RPMs) and penetration/withdrawal rates may be adjusted to achieve adequate mixing. The required rotational speeds and penetration/withdrawal rates for the

various soil layers encountered shall be determined during the test sections.

- B. The shaft rotational speed shall be no less than 20 RPM during penetration and withdrawal. The rotational speeds and penetration/withdrawal rates shall be recorded on the Daily Quality Control Report.
- C. The rotational speeds and penetration/withdrawal rates determined during the test section shall be used during the balance of the work. If these parameters are varied more than 15 percent from those determined during the test sections, the wall section shall be remixed (while injecting grout at the design grout ratio) to a depth at least 3 feet below the deficient zone at no additional cost to the Port.
- D. The Contractor may request that the established mixing parameters be modified during the production wall installation. To verify acceptable results for the modified parameters, the Engineer may require additional testing or a new test section at no additional cost to the Port.

3.08 GROUT INJECTION RATE

- A. The grout injection rate per vertical foot of column shall be in accordance with the requirements of the design mix.
 - 1. The required mix design and grout–soil ratio shall be determined during the test sections.
 - 2. The grout injection rate shall be constantly monitored and controlled.
 - 3. The Contractor shall record the volume of grout injected for each four vertical feet of each column on the Daily Quality Control Report.
- B. If the volume of grout injected per vertical foot of column is less than the amount required to meet the grout–soil ratio established during the test sections, the wall shall be remixed and additional grout injected (at the design grout–soil ratio) to a depth at least 3 feet below the deficient zone, at no additional cost to the Port.
- C. The Contractor may request that the established grout–soil ratio be modified during the production wall installation.
 - 1. To verify acceptable results for the modified grout–soil ratio, the Engineer may require additional testing or a new test section at no additional cost to the Port.

3.09 CONTROL OF SPOILS

- A. The Contractor shall control and process all spoils created during the wall construction.
 - 1. The areas designated on the Plans shall be used for containment and processing the spoils.

2. The spoils shall be processed until they have cured to a sufficient level to allow them to be stockpiled and later used for engineered fill without difficulty (i.e. cured to a level such that they will not reform a cemented mass in the stockpile).

3.10 QUALITY CONTROL PROGRAM

A. General

1. The CDSM Quality Control Program shall be the responsibility of the Contractor and shall include, as a minimum, the following components:
 - a. Construction of at least two tests sections by the Contractor
 - b. Construction of a third test section if required by the Engineer
 - c. Field monitoring by the Contractor of construction parameters during wall construction
 - d. Sample collection including full depth continuous coring, vibra-coring or double tube sampling and wet sampling, along with testing performed by the Contractor (the Engineer will log the core, evaluate uniformity, and select specimens for testing)
 - e. Reporting of the field monitoring, sampling, and strength testing performed by the Contractor
2. The Contractor shall provide all the personnel and equipment necessary to implement the Quality Control Program.
 - a. The Engineer will observe construction on a full-time basis and will review Contractor submittals to check that the Quality Control Program is being properly implemented.
 - b. Prior to site mobilization, the Contractor shall submit a detailed workplan for the Quality Control Program for review and approval by the Engineer.
 - c. The workplan shall include, as a minimum, a description of all procedures to be implemented, parameters to be monitored, tolerances for the parameters monitored, and the names of any subcontractors used for testing.
3. Following the test sections, the Contractor may revise the Quality Control Program, if agreed to by the Engineer. Also, based on the results of the test sections, the Engineer may require that the Quality Control Program be revised.
 - a. The established quality control procedures shall be maintained throughout the production wall installation to

ensure consistency in the CSDM wall installation and to verify that the work complies with all requirements indicated in the Plans and Specifications.

B. Sample Collection and Strength Testing

1. The acceptance of the work will be based on demonstrating that the in-place grout mix together with the soils has achieved the strength and uniformity requirements defined in Paragraph 3.11.
 - a. Verification that the strength and uniformity requirements have been satisfied will be determined solely by the Engineer based on the results of full-depth continuous sampling, discrete wet sampling, and strength testing of samples as described below.
2. Confirmation that the strength and uniformity requirements have been satisfied will be determined by a series of tests performed on samples collected by the Contractor. Confirmation sample collection and testing shall include:
 - a. Full-depth continuous sampling including coring, vibra-coring or double tube sampling and testing: Full-depth continuous sampling performed by the Contractor, review by the Engineer of continuous samples recovered by the Contractor, and laboratory unconfined compressive strength testing conducted by an Engineer approved independent laboratory retained by the Contractor.
 - b. Additional confirmation testing: In addition to confirmation tests performed by the Contractor, other confirmation tests may be performed by the Engineer on samples collected by the Contractor. Both the Contractor's testing and the Engineer's testing (if performed) must demonstrate that the required strengths are met prior to acceptance of the work.
3. Full-Depth Coring, Sampling and Testing: At locations designated by the Engineer, continuous coring, vibra-coring or double tube sampling shall be performed for the full depth of the wall by the Contractor. The frequency of sampling is specified in paragraph 3.10.C for the test sections and 3.10.D for the production wall construction.
 - a. Full-depth samples obtained by the contractor shall have a diameter of at least 2.5 inches. Samples shall be retrieved from locations selected by the Engineer.
 - 1) Unless otherwise directed by the Engineer, the full-depth samples shall be obtained along an essentially vertical alignment located one-fourth of a column diameter from the column center.

- 2) The Contractor shall perform all full–depth sampling in the presence of the Engineer.
 - 3) The Contractor shall notify the Engineer at least one business day in advance (24 hours) of beginning sampling operations.
- b. Full–depth samples shall be retrieved using standard continuous coring techniques after the soil–grout mixture has hardened sufficiently, or using vibra–core or double tube sampling techniques while the soil– grout mixture is wet.
- 1) The double tube sampler consist of an inner sample tube and an outer sleeve with grease between the sleeve and sampler tube.
 - 2) The two tubes are inserted into the wet soil/grout mix and the inner sample tube retrieved after the mix has hardened sufficiently.
- c. For the continuous coring method, each core run shall be at least 4 feet in length and contain at least four test specimens with a length to diameter ratio of 2, or greater.
- 1) A minimum recovery of 85 percent for each 4–foot–long core run shall be achieved, except for CDSM column produced in gravelly soils (as agreed to by the engineer). During coring, the elevation of the bottom of the holes shall be measured after each core run in order that the core recovery for each run can be calculated.
 - 2) The Contractor shall determine the time interval between column installation and coring except that the interval shall be no longer than required to conduct 28–day strength testing.
- d. Upon retrieval, the full–depth samples shall be given to the Engineer for logging and test specimen selection.
- 1) Field logging will be performed by the Engineer to determine if the uniformity and recovery criteria have been satisfied.
 - 2) Following logging, the Engineer will select four to ten specimens from each full–depth sample recovered for strength testing.
 - 3) Following logging and test specimen selection by the Engineer, the entire full–depth sample, including the designated test specimens, shall be immediately sealed in plastic wrap to prevent

drying and transported to the laboratory by the Contractor.

- 4) All core holes shall be filled with cement grout that will obtain a 28-day strength equal to or greater than the strength of the CDSM.
- e. Strength testing shall be conducted by an Engineer approved independent testing laboratory retained by the Contractor.
- 1) The samples shall be stored in a moist room in accordance with ASTM C192 until the test date.
 - 2) Testing for 28-day unconfined compressive strength shall be conducted in accordance with ASTM D2166.
 - 3) The remaining portions of the full-depth samples that are not tested shall be retained by the Contractor, until completion and acceptance of all CDSM walls, for possible inspection and confirmation testing by the Engineer.
 - 4) The Port shall pay for additional confirmation testing.

C. Test Section

- 1 Prior to construction of the production CDSM walls, two or three test sections shall be prepared by the Contractor to verify that the required geometric tolerances and design strengths can be achieved and that the installation methods provide adequate mixing and penetration for the existing field conditions at the project site. The Contractor may construct more than two test sections using various mixing designs, if desired.
2. The test sections shall be installed behind the proposed wharf at the locations indicated on the Plans.
 - a. Each section shall consist of walls arranged in the indicated pattern and constructed to the depths shown on the Plans.
 - b. The cement dosage used for the approved test sections will be required for use in the production wall construction.
 - c. Equipment and procedures used on the test sections shall be identical to those proposed for the production wall construction.
 - d. If procedures or equipment are changed following the test sections, the Engineer reserves the right to request a new test section at the Contractor's expense.

3. Based on the test section results obtained from the adjacent Berth 55/56 project, the following procedures shall be used initially in the shallow mud test section unless other procedures are proposed by the Contractor and approved by the Engineer.
 - a. The augers shall advance during the penetration stroke at a rate not exceeding 4 feet per minute and at a rotation speed of approximately 20 revolutions per minute, except that below Elevation -15 feet the penetration rate shall be decreased to no greater than 2.5 feet per minute.
 - b. Also the bottom mixing at each column location shall consist of raising and lowering the augers 5 feet at a rotational rate of 40 revolutions per minute.
 - c. If the advancement of the augers stops for more than one minute during construction of a column, the Contractor shall pump a quantity of grout equal to that required to improve 3 vertical feet of soil prior to resuming advancement of the augers.
4. The Contractor shall obtain samples from the test section and submit them to an approved laboratory for strength testing.
 - a. Sampling and testing shall be performed in accordance with the requirements of Paragraph 3.10.B. For each test section, a minimum of four full-depth continuous cores, vibra-cores or double tube samples shall be collected from the entire column length at locations selected by the Engineer.
 - b. The Contractor may propose other sampling techniques to obtain continuous samples of the CDSM columns which, if approved by the Engineer, could be substituted either for coring, vibra-coring, or double tube sampling.

D. Production Wall Construction

1. The production walls shall be constructed using the same grout mix design, procedures and equipment that were used for the test sections. If the mix design, procedures or equipment used for the test section are changed, the Engineer reserves the right to request a new test section, sampling, and testing at the expense of the Contractor.
2. The Contractor shall conduct sampling and testing of the production walls using the same methods employed during the test sections and in accordance with the requirements listed in paragraph 3.10.B.
 - a. For the production wall construction, the following minimum testing frequency shall be instituted: Collect one full-depth continuous core, vibra-core, or double tube sample of the wall, at a location selected by the Engineer,

for every 500 lineal feet (horizontal distance) of wall installed. (for every 2000 cubic meters of CDSM wall installed.)

- b. This sampling requirement is based on lineal feet of wall installed, including both horizontal and transverse walls, and is not based on lineal feet of shoreline stabilized. Perform strength tests on specimens selected by the Engineer from the full-depth samples in accordance with the requirements of paragraph 3.10.B.

E. Daily Quality Control Report

1. The Contractor shall submit Daily Quality Control Reports to the Engineer at the end of the next working day. The Daily Quality Control Report shall document the progress of the wall construction, present the results of the QC parameter monitoring, present the results of the strength testing, and clearly indicate if the columns have meet the acceptance criteria.
2. The Daily Quality Control Report shall include as a minimum the results of the following QC parameter monitoring for each column:
 - a. Rig number
 - b. Type of mixing tool
 - c. Date and time (start and finish) of column construction
 - d. Column number and reference drawing number
 - e. Column diameter
 - f. Column top and bottom elevations
 - g. Grout mix design designation
 - h. Slurry specific gravity measurements
 - i. Description of obstructions, interruptions, or other difficulties during installation and how they were resolved
3. The Daily Quality Control Reports shall also include the following parameters recorded automatically or manually for each column at intervals no greater than 4 feet and submitted in the form of either tables of figures (as agreed to by the Engineer):
 - a. Elevation in feet vs. real time
 - b. Shaft rotation speed in RPMs vs. real time
 - c. Penetration and withdrawal rates in feet per minute vs. real time

- d. Grout injection rate in gpm vs. real time
- e. The average quantity of grout in gallons per foot injected per vertical foot of column vs. depth

3.11 ACCEPTANCE CRITERIA

- A. The Engineer shall make the sole determination as to whether the test results indicate that the acceptance criteria have been satisfied. The in-place grout/soil mixture comprising the CDSM walls shall meet the following acceptance criteria:
 - 1. The walls shall be installed within the following geometric tolerances:
 - a. The horizontal alignment of the walls shall be within 6 inches of the planned location at the top of wall (Elevation +6 feet)
 - b. The vertical inclination of the walls shall be no more than 1:100 (horizontal to vertical)
 - c. The column overlap between any two adjacent columns shall be at least 20 percent of the area of a single column at surface and the vertical alignment of 1% as specified in Paragraph 3.03A shall be maintained during the wall installation.
 - d. The tops of the walls shall extend up to Elevation +6 feet, or higher
 - e. The bottom of the wall shall extend down at least as deep as indicated on the Plans or as modified by the Engineer in the field.
 - 2. An average unconfined compressive strength of 100 psi and 150 psi at 28 days and 90 days, respectively, determined as outlined in Paragraph 3.10.B and as determined by ASTM D2166.
 - a. The average strength shall be computed by summing all individual unconfined compressive strength tests performed on any full-depth sample and dividing by the number of tests.
 - b. Not more than 5 percent of the samples tested shall exhibit an unconfined compressive strength of less than 60% of the average unconfined compressive strength.
 - 3. Uniformity of mixing shall be evaluated by the Engineer based on the full-depth samples recovered by the Contractor from the walls.

- a. Lumps of unimproved soils shall not amount to more than 20 percent of the total volume of any 4-foot section of continuous full-depth core sample. Any individual or aggregation of lumps of unimproved soil shall not be larger than 12 inches in greatest dimension.
 - b. In addition, continuous core recovery shall be at least 85 percent over any 4-foot core run. For evaluating the volume of unimproved lumps of soil, all of the unrecovered core length shall be assumed to be unimproved soil.
- B. If the acceptance criteria specified in Paragraph 3.11.A are not achieved for production walls, the failed section of walls shall be rejected.
1. Unless otherwise determined by the Engineer, the failed section of walls shall be considered to include all walls constructed during all rig shifts that occurred between the times of construction when passing tests were achieved.
 2. The Contractor may conduct additional sampling and testing to better define the limits of the failed area at no additional cost to the Port.
 3. The Contractor shall submit a proposed plan for remixing or repair of failed sections for review and approval by the Engineer.

END OF SECTION

APPENDIX C

DM CONTRACTOR INFORMATION

Deep Mixing Technology for Excavation Support

Contractor Questionnaire:

As part of a research project on “Guidelines for Excavation Support using Deep Soil Mixing” funded by the National Deep Mixing Research Program, we are compiling information from various contractors. The information will be assembled into the appendices of the national design manual for excavation support using deep mixing technology. We would like to include your company and any information you can provide. Please answer the following questions (2 pages) and return the questionnaire along with any additional information to the address at the end of page 2.

COMPANY INFORMATION
Company Name: <u>Condon Johnson & Assoc. Inc</u>
Address: <u>1840 Embarcadgro</u>
Contact person, email, telephone: _____
Technology Name/Acronym: <u>Geo – Jet</u> (ex. Deep Soil Mixing, DSM)

DEEP MIXING INFORMATION
Equipment used: <u>Single and Double Axis Mixing</u> (ex. 3 axis augers)
<u>Tools – Grout Introduced Thru High Pressure (up to 4500 psi) Tri-Plex Pumping System</u>
Standard specifications used: _____ (ex. Strength requirements)
Quality control program: <u>Coring, In- situ sampling, nuclear density testing of grout, plant</u> (ex. Coring and in situ sampling)
<u>Plant output, Jan Lute Mixing Monitoring System – rotation, penetration, torque, flow</u>
Production rates: <u>Varies widely, up to 400 cy/day</u> (ex. ft ³ per day)
Average costs for excavation support projects: <u>Proprietary</u> (ex. \$/ft ² of wall)

Additional information:

**Please send the questionnaire back by email to:
Professor Jean-Louis Briaud, briaud@tamu.edu**

**Or by mail to:
Professor J.-L. Briaud
Dept. of Civil Engineering
Texas A&M University
College Station, TX 77843-3136**

Deep Mixing Technology for Excavation Support

Contractor Questionnaire:

As a part of research funded by the National Deep Mixing Research Program, we are compiling information from various contractors. The information will be assembled into the appendices of a national design manual for excavation support using deep mixing technology. We would like to include your company and any information you can provide. Please take a few minutes and fill in the following questions. Please feel free to send any additional information to the address below.

COMPANY INFORMATION	
Company Name:	<u>Hayward Baker Inc.</u>
Address:	<u>1130 Annapolis Road, Odenton, MD 21113</u> <u>Plus 19 offices nationwide</u>
Technology Name/Acronym:	<u>Wet Soil Mixing</u> (ex. Deep Soil Mixing, DSM)

DEEP MIXING INFORMATION	
Equipment used:	<u>Single axis, 4 to 8 ft diameter tooling to depths of about 60 ft. System</u> (ex. 3 axis augers) <u>best suited to constructing gravity walls where internal bracing or tiebacks are precluded.</u> <hr/> <hr/>
Standard specifications used:	<u>This is design dependent, but generally low strength</u> (ex. Strength requirements) <u>requirements offer acceptable safety factors.</u> <hr/> <hr/>
Quality control program:	<u>Real time monitoring and data recording of all parameters; in situ wet</u> <u>sampling and coring for verification.</u> (ex. Coring and in situ sampling)

Production rates: 200 to 1,000 cy per rig shift depending on tool diameter.

(ex. ft³ per day)

Average costs for excavation support projects: Design dependent.

(ex. \$/ft² of wall)

Additional information: In situ gravity walls are cost effective when:

1. The owner wants clear, open space (no internal bracing); and
2. Right-of-way restriction precludes tiebacks.

They can also be utilized in combination with other design issues such as seismic

Spreading remediation.

Please send the questionnaire back by email to:

Professor Jean-Louis Briaud, briaud@tamu.edu

Or by mail to:

Professor J.-L. Briaud

Dept. of Civil Engineering

Texas A&M University

College Station, TX 77843-3136

Deep Mixing Technology for Excavation Support

Contractor Questionnaire:

As part of a research project on "Guidelines for Excavation Support using Deep Soil Mixing" funded by the National Deep Mixing Research Program, we are compiling information from various contractors. The information will be assembled into the appendices of the national design manual for excavation support using deep mixing technology. We would like to include your company and any information you can provide. Please answer the following questions (2 pages) and return the questionnaire along with any additional information to the address at the end of page 2.

COMPANY INFORMATION	
Company Name:	<u>Raito Inc.</u>
Address:	<u>1660 Factor Ave., San Leandro, CA 94577</u>
Contact person, email, telephone:	<u>David S. Yang, dsyang@raitoinc.com, 510-346-9840</u>
Technology Name/Acronym: (ex. Deep Soil Mixing, DSM)	<u>Deep Soil Mixing (DSM), Raito Soil Walls (RSW), and Cement Deep Soil Mixing (CDSM)</u>

DEEP MIXING INFORMATION	
Equipment used: (ex. 3 axis augers)	<u>3-axis augers, crawler base machine, and Batch Plant.</u>
Standard specifications used: (ex. Strength requirements)	<u>See Attached Paper, "Sample Specifications for Soil-Cement Excavation Support Wall Constructed by Cement Deep Soil Mix (CDSM) Method.</u>
Quality control program: (ex. Coring and in situ sampling)	<u>Computer based real time QC system for wall installation. Wet grab samples for quality control testing of strength.</u>
Production rates: (ex. ft ³ per day)	<u>150 cubic yards (4050 cubic feet) to 250 cubic yards (6750 cubic feet) per 8-hour day per rig.</u>
Average costs for excavation support projects: (ex. \$/ft ² of wall)	<u>\$10 to \$12 per square feet of wall without steel reinforcement.</u>

Additional information: This 3-axis auger equipment has been used for the construction of more than 3,000 soil-cement walls for excavation support and groundwater control in the United States and Japan. For more details, please see the attached article entitled "Soil-Cement Walls for Excavation Support".

**Please send the questionnaire back by email to:
Professor Jean-Louis Briaud, briaud@tamu.edu
Or by mail to:
Professor J.-L. Briaud
Dept. of Civil Engineering
Texas A&M University
College Station, TX 77843-3136**